

JVC

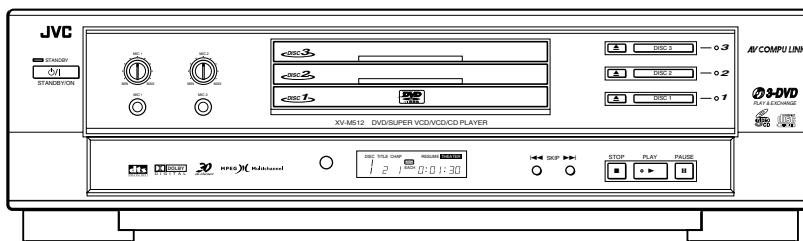

DVD VIDEO PLAYER

XV-M512SL

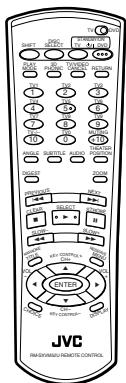

Introduction	3
Preliminary knowledge	6
Getting started	16
Basic operations	23
Advanced operations	27
MP3 disc playback	42
KARAOKE operation	46
Initial settings	53
Additional information	60

INSTRUCTIONS

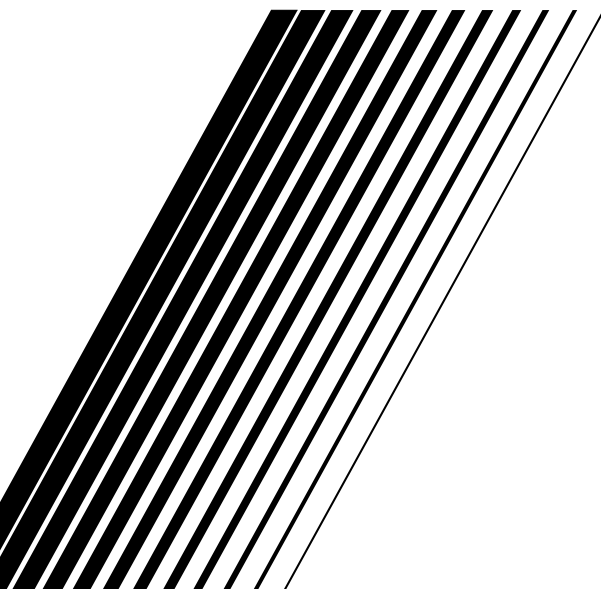

Warnings, Cautions and Others

CAUTION

To reduce the risk of electrical shocks, fire, etc.:

1. Do not remove screws, covers or cabinet.
2. Do not expose this appliance to rain or moisture.

Caution — ⏻/⏻ switch!

Disconnect the mains plug to shut the power off completely. The ⏻/⏻ switch in any position does not disconnect the mains line. The power can be remote controlled.

CAUTION:

- Do not block the ventilation openings or holes.
(If the ventilation openings or holes are blocked by a newspaper or cloth, etc., the heat may not be able to get out.)
- Do not place any naked flame sources, such as lighted candles, on the apparatus.
- When discarding batteries, environmental problems must be considered and local rules or laws governing the disposal of these batteries must be followed strictly.
- Do not expose this apparatus to rain, moisture, dripping or splashing and that no objects filled with liquids, such as vases, shall be placed on the apparatus.

Caution: Proper Ventilation

To avoid risk of electric shock and fire and to protect from damage.

Locate the apparatus as follows:

- Front: No obstructions open spacing.
- Sides: No obstructions in 3 cm from the sides.
- Top: No obstructions in 5 cm from the top.
- Back: No obstructions in 15 cm from the back
- Bottom: No obstructions, place on the level surface.

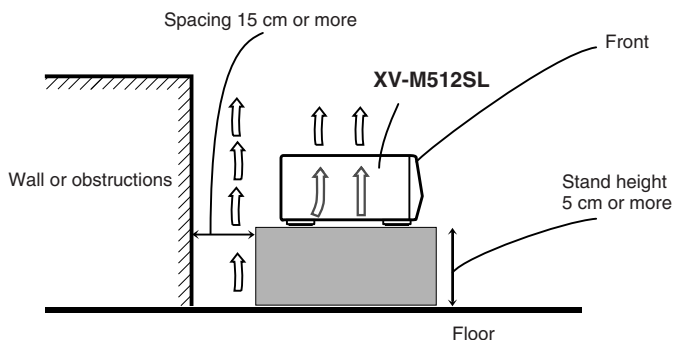

IMPORTANT FOR LASER PRODUCTS

REPRODUCTION OF LABELS

① CLASSIFICATION LABEL, PLACED ON REAR ENCLOSURE

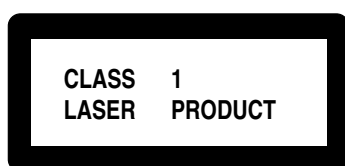

② WARNING LABEL, PLACED INSIDE THE UNIT

<p>CAUTION: Invisible laser radiation when open and interlock failed or defeated. AVOID DIRECT EXPOSURE TO BEAM. (e)</p>	<p>WARNING: Osynlig laserstrålning när denna del är öppnad och spärren är urkopplad. Betrakta ej strålen. (s)</p>	<p>ADVARSEL: Usynlig laserstrålning ved åbning, når sikkerhedsafbrydere er ude af funktion. Undgå udsættelse for stråling. (d)</p>	<p>VARO: Avattaessa ja suojalukitus ohitettaessa olet alttiina näkymättömälle lasersäteilylle. Älä katso säteseen. (f)</p>
---	--	---	---

1. CLASS 1 LASER PRODUCT
2. **DANGER:** Invisible laser radiation when open and interlock failed or defeated. Avoid direct exposure to beam.
3. **CAUTION:** Do not open the top cover. There are no user serviceable parts inside the Unit; leave all servicing to qualified service personnel.

Table of Contents

Introduction	Page 3
Features	3
Supplied accessories	3
About this instruction manual	4
Notes on handling	5
Preliminary knowledge	Page 6
Names of parts and controls	6
Front panel.....	6
Display window.....	7
Remote control unit.....	8
Rear panel.....	10
Operational Principles	11
On-screen displays.....	11
To prevent the monitor from burning out [SCREEN SAVER].....	13
On-screen guide icons.....	13
How to use numeric buttons.....	14
About discs	15
Playable disc types.....	15
Disc structure.....	15
Getting started	Page 16
Connections	16
Before making any connections.....	16
To connect to a TV.....	16
To connect to a TV with the component video input jacks.....	17
To connect to an audio amplifier or receiver.....	18
To connect to audio equipment with a digital input.....	18
To connect the power cord.....	19
Using the remote control unit	20
To install batteries in the remote control unit.....	20
To use the remote control unit for TV operation.....	21
Basic operations	Page 23
Turning on/off the unit	23
Inserting and removing discs	23
Basic playback	24
To start playback.....	24
To stop playback completely.....	24
To stop playback temporarily.....	24
To advance or reverse playback rapidly while monitoring.....	25
To locate the beginning of the scene or song.....	25
Resuming playback	26
To memorize the interrupted position.....	26
To resume playback.....	26
Advanced operations	Page 27
Playing from a specific position on a disc	27
To locate a desired scene from the DVD menu.....	27
To locate a desired scene from the menu of the Video CD/SVCD with PBC.....	27
To locate a desired selection using the numeric buttons.....	28
To locate a desired selection using ◀◀ or ▶▶.....	28
To locate a desired scene by specifying the chapter number [CHAP.SEARCH].....	29

To locate a desired position in the current title or track [TIME SEARCH].....	29
To locate a desired scene from the display [DIGEST].....	30
Special picture playback	31
To advance a still picture frame-by-frame.....	31
To display continuous still pictures [STROBE].....	31
To playback in slow-motion [SLOW].....	32
To zoom a scene [ZOOM].....	32
Changing the playback order	33
To playback in the desired order [PROGRAM].....	33
To playback in random order [RANDOM].....	34
Repeat playback	34
To repeat the current selection or all discs contents [REPEAT].....	34
To repeat a desired part [A-B REPEAT].....	35
Selecting a scene angle of DVD VIDEO	36
To select a scene angle from the normal screen [ANGLE].....	36
To select a scene angle from the angle list display [ANGLE].....	37
Changing the language and sound	37
To select the subtitle language [SUBTITLE].....	37
To change the audio language or sound [AUDIO].....	38
Selecting the picture character	39
To select the picture character [THEATER POSITION].....	39
Enjoying virtual surround sound	39
To simulate surround sound [3D PHONIC].....	39
Checking the status	40
To check the disc/time information.....	40
To check the DVD function status.....	41
To dim, the brightness of the display window	41
Dimming the brightness of the display window.....	41

MP3 disc playback	Page 42
About MP3 disc	42
Unavailable functions	42
Basic operations	42
Basic operations using the basic control buttons.....	42
Track/Group selection using the numeric buttons.....	43
Advanced functions	43
Program playback.....	43
Random playback.....	44
Repeat playback.....	45
Disc/time information.....	45

KARAOKE operation	Page 46
Preparation	46
Turning on the KARAOKE function.....	46
Reserving songs	47
To playback songs reserved.....	47
Selecting audio	48
Selecting audio track(s) [AUDIO].....	48
Selecting KARAOKE sound [KARAOKE SOUND].....	48
Masking the vocal recorded on a disc [VOCAL MASK].....	49
Playing back the guide vocal only when you stop singing [VOCAL REPLACE].....	50
Adding an effect to your voice	51
Adding an echo effect [ECHO].....	51
Adding various effects to the vocal [VOCAL EFFECT].....	51
Shifting the musical key	52
To shift the musical key.....	52

Initial settings	Page 53
Selecting preferences	53
How to set preferences	53
LANGUAGE page	53
AUDIO page	54
DISPLAY page	55
SYSTEM page	56
Limiting playback by children	57
To set Parental Lock for the first time	
[PARENTAL LOCK]	57
To change the settings [PARENTAL LOCK]	58
To temporarily release the Parental lock	
[PARENTAL LOCK]	59
Additional information	Page 60
AV COMPU LINK remote control system	60
Connection and setup	60
Operation	61
Care and handling of discs	62
Troubleshooting	63
Specifications	64
Table of languages and their abbreviations ..	Appendix A
Country code list for parental lock	Appendix B

Features

Picture functions

■ Strobe function

The unit can display nine continuous still pictures on the TV screen.

■ Digest function

You can select the desired selection to be played from the opening scenes displayed on the TV screen.

■ Angle function*

You can select a desired angle from multiple camera angles recorded on the DVD VIDEO disc.

■ Zoom function

You can view scenes close-up.

■ Parental lock*

You can restrict the playback of DVD VIDEO discs with scenes which you do not want children to see, such as adult or violent films.

■ Theater position

You can select the picture character according to the lighting of your room.

Audio functions

■ High quality digital sound

You can enjoy high quality sound with Dolby Digital or Linear-PCM.

■ Surround function*

The unit accommodates the Dolby Digital and, DTS surround systems.

(These surround signals are output only from the DIGITAL OUT jacks.)

■ 3D Phonic function

You can enjoy surround sound with your 2-channel system.

Other functions

■ Triple disc trays

You can insert up to three discs in the unit and can playback them continuously.

■ Multi-language subtitles and sound*

You can select a subtitle or sound language from those recorded on the DVD VIDEO disc.

■ Multi-disc playback

You can enjoy Audio CD, Video CD and SVCD discs, as well as DVD VIDEO discs.

This unit can playback CD-R/RW discs recorded by the MP3 format (we refer to those discs as MP3 discs in this manual).

■ Operation from the on-screen display

User-friendly on-screen displays allow you to operate the unit easily.

■ KARAOKE function

You can enjoy singing KARAOKE using various functions including echo and chorus effects.

Functions with (*) mark only work on a DVD VIDEO disc that is compatible with each function.

Supplied accessories

- Audio/video cable (x 1)

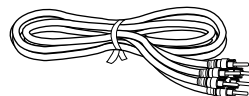

- AV compulink cable (x 1)

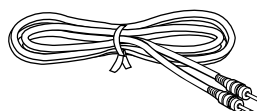

- Remote Control Unit (x 1)

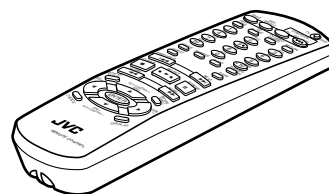

- R6P(SUM-3)/AA(15F) batteries (x 2)

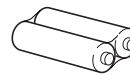

- AC power cord (x 1)

About this instruction manual

- This instruction manual basically explains operations according to the format as below.
- For operations for MP3 discs, see "MP3 disc playback" on and after page 42. The other sections of this manual do not refer to MP3 disc playback.

To playback in random order [RANDOM]



You can play titles or tracks on discs inserted in random order by using the Random function.

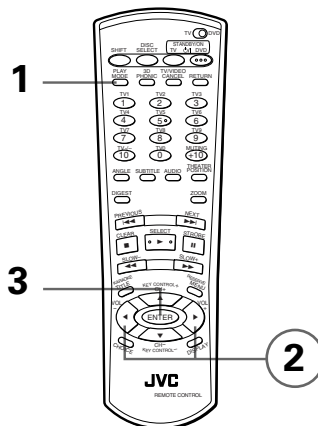

These symbols indicate the types of discs which the operation can be used for.

The number indicates the following procedural step(s) in which the button(s) is(are) used. You may also use the corresponding buttons on the front panel of the unit if available.

■ While stopped

1 Press PLAY MODE.

The play mode menu appears on the TV screen.

The number indicates the procedural step.

2 Use CURSOR ◀▶ to move [RANDOM].

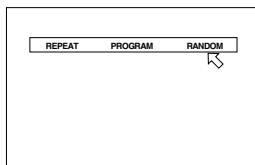

3 Press ENTER.

The unit starts random playback. The "RANDOM" indicator appears in the display window on the front panel. After playing all titles/tracks of the discs, random playback ends.

The names of buttons on the remote control unit (or on the front panel of the unit) are all given in uppercase letters.

Other convenient procedures, etc.

Hints

- The same title or track will not be played back more than once during random play.
- **To stop/quit random playback in the middle**
Press ■ to stop playback. The unit is still in random playback mode, so pressing ▶ starts random playback again.
To quit random playback, press ■ again while stopped. The "RANDOM" indicator in the display window turns off.

Additional supplemental remarks.

NOTE

- Some DVD VIDEO discs may not be played back correctly in the random mode.

Notes on handling

Important cautions

Installation of the unit

- Select a place which is level, dry and neither too hot nor too cold (between 5°C and 35°C).
- Leave sufficient distance between the unit and the TV.
- Do not use the player in a place subject to vibrations.

Power cord

- Do not handle the power cord with wet hands!
- A small amount of power (3.1 W) is always consumed while the power cord is connected to the wall outlet.
- When unplugging the player from the wall outlet, always pull the plug, not the power cord.

To prevent malfunction of the unit

- There are no user-serviceable parts inside. If anything goes wrong, unplug the power cord and consult your dealer.
- Do not insert any metallic object into the unit.
- Do not use any non-standard shape disc available on the market, because it may damage the unit.
- Do not use a disc with tape, seals, or paste on it, because damage to the unit may result.

Note about copyright laws

- Please check the copyright laws in your country before recording from DVD VIDEO, Audio CD, Video CD, SVCD and MP3 discs. Recording of copyrighted material may infringe copyright laws.

Note about the copyguard system

- The DVD VIDEO disc is protected by the copyguard system. When you connect the unit to your VCR directly, the copyguard system activates and the picture may not be played back correctly.

Safety precautions

Avoid moisture, water and dust

Do not place the unit in moist or dusty places.

Avoid high temperatures

Do not expose the unit to direct sunlight or place it near a heating device.

When you're away

When away on travel or otherwise for an extended period of time, remove the plug from the wall outlet.

Do not insert foreign objects into the unit

Do not insert wires, hairpins, coins, etc. into the unit.

Do not block the vents

Blocking the vents may damage the unit.

Care of the cabinet

When cleaning the unit, use a soft cloth and follow the relevant instructions on the use of chemically-coated cloths. Do not use benzene, thinner or other organic solvents and disinfectants. These may cause deformation or discoloring.

If water gets inside the unit

Turn off the power switch and remove the plug from the wall outlet, then call the store where you made your purchase. Using the unit in this state may cause a fire or electrical shock.

This product incorporates copyright protection technology that is protected by method claims of certain U.S. patents and other intellectual property rights owned by Macrovision Corporation and other rights owners. Use of this copyright protection technology must be authorized by Macrovision Corporation, and is intended for home and other limited viewing uses only unless otherwise authorized by Macrovision Corporation. Reverse engineering or disassembly is prohibited.

Manufactured under license from Dolby Laboratories. "Dolby" and double-D symbol are trademarks of Dolby Laboratories.

Confidential Unpublished Works.

© 1992-1997 Dolby Laboratories, Inc. All rights reserved.

Manufactured under license from Digital Theater Systems, Inc. US Pat. No. 5,451,942 and other world-wide patents issued and pending. "DTS"; "DTS Digital Surround"; are trademarks of Digital Theater Systems, Inc.

© 1996 Digital Theater Systems, Inc. All Rights Reserved.

Names of parts and controls

Refer to the corresponding pages indicated in () for details.

Front panel

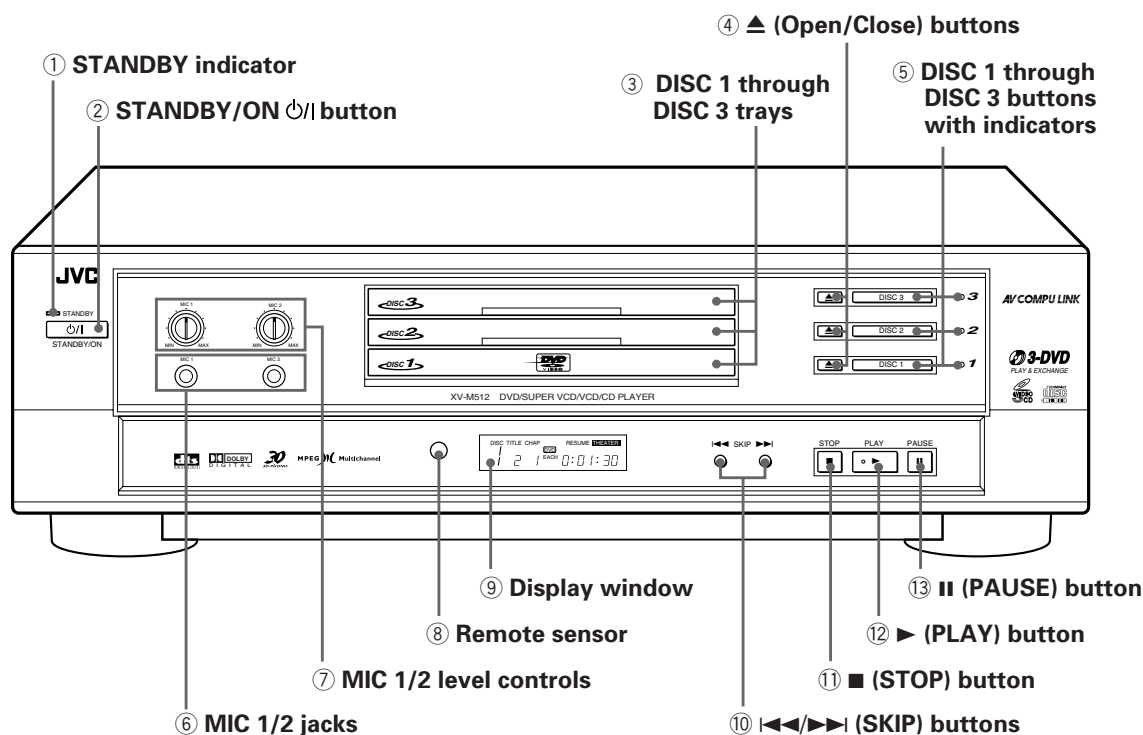

① STANDBY indicator

Lights when the power cord is connected and the unit is on standby. When the unit is turned on, the STANDBY indicator goes off.

② STANDBY/ON \odot/I button (23)

Turns the unit on or off (standby).

③ DISC 1 through DISC 3 trays (23)

Used to load discs. To insert/remove a disc, press the \blacktriangle (Open/Close) button.

④ \blacktriangle (Open/Close) buttons (23)

Used to open and close the corresponding disc trays (1 to 3).

⑤ DISC 1 through DISC 3 buttons with indicators

Used to start playback of the disc in the corresponding tray with the number indicated on the button. While playing, the corresponding indicator blinks.

⑥ MIC 1/2 jacks (46)

Used to connect microphones.

⑦ MIC 1/2 level controls (46)

Used to control the input level of microphones connected to the MIC 1/2 jacks.

⑧ Remote sensor

Receives signals from the remote control unit.

⑨ Display window (7)

Indicates the current status of the unit.

⑩ $\blacktriangleleft/\blacktriangleright$ (SKIP) buttons (25, 42)

Used to skip a chapter, title or track.

Also, used for the page selection of a menu screen (for Video CD/SVCD).

Holding down \blacktriangleleft or \blacktriangleright during playback reverses or advances playback rapidly (except MP3 disc).

⑪ \blacksquare (STOP) button (24, 42)

Stops playback.

Also used to change the video output setting (See page 17).

⑫ \blacktriangleright (PLAY) button (24, 42)

Starts playback. Also, used as a SELECT button for PBC of Video CDs/SVCDs.

⑬ II (PAUSE) button (24, 31, 42)

Pauses playback.

Also, used to display nine continuous still pictures (STROBE function).

Display window

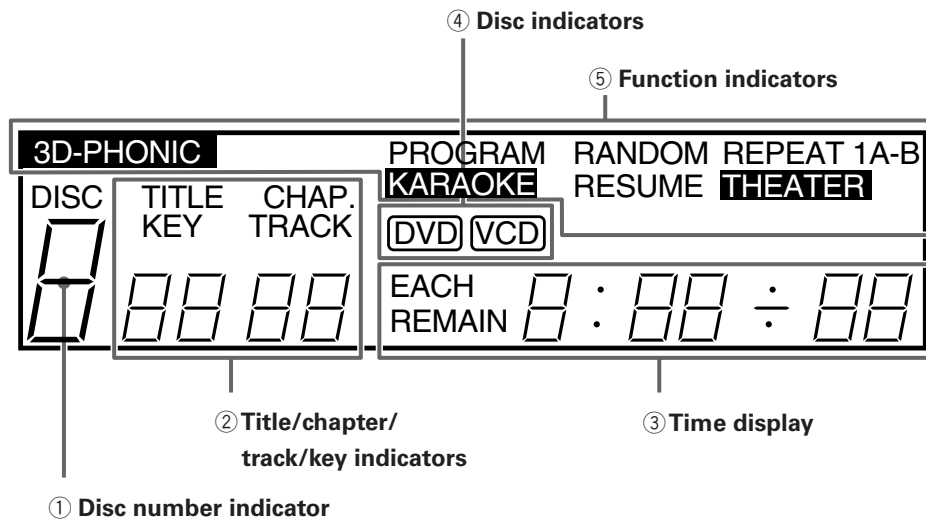

① Disc number indicator

Shows the disc number being selected.

② Title/chapter/track/key indicators

Usually displays the title/chapter, or track number. When you shift the musical key, the status is displayed. For example, if you lower the key two levels, the display shows “-2”.

③ Time display

Shows the cumulative or remaining time of the track or disc, or the total disc time.

④ Disc indicators

Indicator the type of the disc set in the selected tray. When a DVD VIDEO is set, “DVD” is indicated. When a Video CD or SVCD disc is set, “VCD” is indicated. When an Audio CD or MP3 disc is set, there is no indication.

⑤ Function indicators

Active functions light up.

Remote control unit

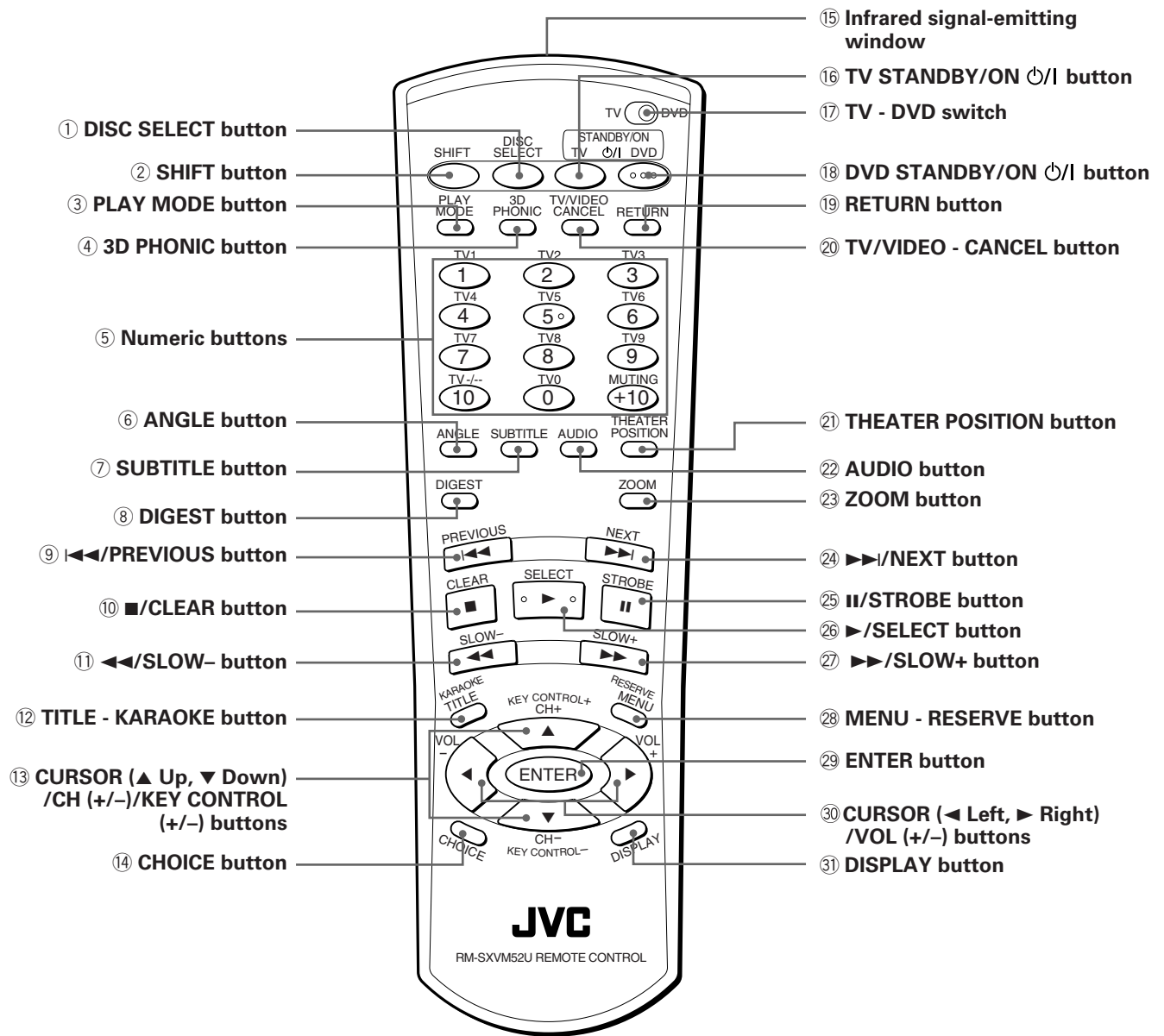

- ① **DISC SELECT button (24, 33, 43, 47)**
By pressing this button followed by the appropriate numeric button (among 1 through 3), you can select a disc to be played.
- ② **SHIFT button (46, 47, 52)**
Used together with other buttons for activating their secondary functions for KARAOKE.
- ③ **PLAY MODE button (29, 33, 34, 35, 43 - 45)**
Displays an on-screen display for controlling the advanced playback functions.
- ④ **3D PHONIC button (39)**
Produces a simulated surround effect.

- ⑤ **Numeric buttons (14, 21, 47)**
When the TV - DVD switch is set to DVD, these buttons are used to specify a disc, title, chapter, track or group number, as well as used to enter a time for the Time search function.
When the TV - DVD switch is set to TV, these buttons are used to select a TV channel as well as mute the TV audio.
- ⑥ **ANGLE button (36, 37, 41)**
Changes camera angles during playback of a DVD VIDEO disc containing multiple camera angles.

- ⑦ **SUBTITLE button (37)**
Used to display the subtitle selection display on the TV screen, as well as used to turn the subtitle on or off (for DVD VIDEO).
- ⑧ **DIGEST button (30)**
Displays beginning scenes of each title, chapter or track on the TV screen (for DVD VIDEO/Video CD/SVCD).
- ⑨ **◀◀/PREVIOUS button (25, 28, 42)**
Skips back a chapter, title or track. Also used for the page selection of a menu screen (for DVD VIDEO/Video CD/SVCD).
Holding down this button during playback reverses playback rapidly (except MP3 disc).
- ⑩ **■/CLEAR button (24, 33, 42, 44)**
Stops playback. Also used to erase all the programmed selection for the program play.
- ⑪ **◀◀/SLOW- button (25, 32, 42)**
Pressing this button during playback reverses playback rapidly (except MP3 disc).
With an MP3 disc, pressing this button skips back a Group.
Pressing this button while a DVD VIDEO disc is paused reverses playback slowly.
- ⑫ **TITLE - KARAOKE button (27, 46)**
Displays the title menu of a DVD VIDEO disc on the TV screen.
Pressing this button while holding down the SHIFT button turns the KARAOKE function on or off.
- ⑬ **CURSOR (▲ Up, ▼ Down)/CH (+/-)/KEY CONTROL (+/-) buttons**
When the TV - DVD switch is set to DVD, these buttons are used to select an item from a menu or on-screen display, or to change the setting of an on-screen display item.
When the TV - DVD switch is set to TV, they are used to select a TV channel.
When the KARAOKE function is active, they are used to shift the musical key of a song being played to match with your voice.
- ⑭ **CHOICE button (53)**
Displays the preference on-screen display on the TV screen.
- ⑮ **Infrared signal-emitting window**
Point this window toward the remote sensor on the front panel when pressing buttons.
- ⑯ **TV STANDBY/ON ⏻/⏻ button (21)**
Turns the television on or off (standby).
- ⑰ **TV - DVD switch (14, 21, 27)**
Selects the function of the numeric buttons to control the corresponding device.
- ⑱ **DVD STANDBY/ON ⏻/⏻ button (23)**
Turns the unit on or off (standby).
- ⑲ **RETURN button (28)**
Returns to the previous menu (for DVD VIDEO/Video CD/SVCD).
- ⑳ **TV/VIDEO - CANCEL button (21, 33, 44, 47)**
When the TV - DVD switch is set to TV, this button switches the TV input between TV and VIDEO.
When the TV - DVD switch is set to DVD, it cancels the last programmed selection in the Program mode.
Pressing this button while holding down the SHIFT button cancels reserved songs for KARAOKE, as well as erases the last selection for program playback.
- ㉑ **THEATER POSITION button (39)**
Selects a picture character from 4 options (for DVD VIDEO/Video CD/SVCD).
- ㉒ **AUDIO button (38)**
Selects the audio (for DVD VIDEO/Video CD/SVCD).
- ㉓ **ZOOM button (32)**
Zooms in the picture (for DVD VIDEO/Video CD/SVCD).
- ㉔ **▶▶/NEXT button (25, 28, 42)**
Skips forward a chapter, title or track. Also used for the page selection of a menu screen (for DVD VIDEO/Video CD/SVCD).
Holding down this button during playback advances playback rapidly (except MP3 disc).
- ㉕ **⏸/STROBE button (24, 31, 42)**
Pauses playback. Also, used to display nine continuous still pictures (STROBE function).
- ㉖ **▶/SELECT button (24, 27, 33, 42, 43, 47)**
Starts playback. Also used as a SELECT button for PBC of Video CDs/SVCDs.
- ㉗ **▶▶/SLOW+ button (25, 32, 42)**
Pressing this button during playback advances playback rapidly (except MP3 disc).
With an MP3 disc, pressing this button skips forward a Group.
Pressing this button while a DVD VIDEO, Video CD or SVCD disc is paused advances playback slowly.
- ㉘ **MENU - RESERVE button (27, 47)**
Displays a DVD menu on the TV screen.
Pressing this button while holding down the SHIFT button displays the KARAOKE reservation table on the TV screen.
- ㉙ **ENTER button**
Executes the selected item in a menu or on-screen display.
- ㉚ **CURSOR (◀ Left, ▶ Right)/VOL (+/-) buttons**
When the TV - DVD switch is set to DVD, these buttons are used to select an item from a menu or on-screen display, or to change the setting of an on-screen display item.
When the TV - DVD switch is set to TV, they are used to change the TV audio volume.
- ㉛ **DISPLAY button (40, 41, 45, 48 - 52)**
Displays the status information (only for DVD disc) or the time information (for any types of discs).
When the KARAOKE function is active, pressing this button brings up the KARAOKE menu.

Rear panel

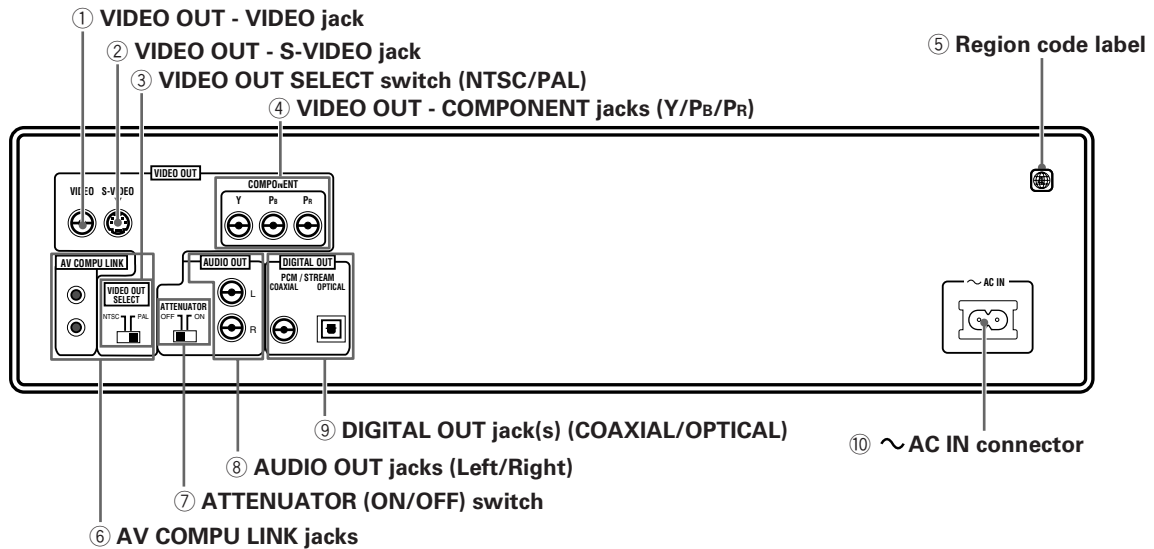

① **VIDEO OUT - VIDEO jack (16)**

Outputs a composite video signal.

② **VIDEO OUT - S-VIDEO jack (16)**

Outputs an S-video signal.

Note that this jack is not active when you make the COMPONENT VIDEO OUT jacks active. See "How to make the COMPONENT VIDEO OUT jacks active" on page 17 for details.

③ **VIDEO OUT SELECT switch (NTSC/PAL) (16)**

Selects "NTSC" or "PAL" to match the color system of your TV. Note that the unit power must be off (standby) when you change the switch position. Otherwise, the changed setting will not be effective.

④ **VIDEO OUT - COMPONENT jacks (Y/P_B/P_R) (17)**

Output component video signals.

These jacks are not active in the initial (factory preset) condition. See "How to make the COMPONENT VIDEO OUT jacks active" on page 17 for details.

⑤ **Region code label (15)**

Shows region code number.

⑥ **AV COMPU LINK jacks (60)**

Connects with other JVC equipment supporting the AV Compulink function to facilitate integrated operations.

⑦ **ATTENUATOR (ON/OFF) switch (16)**

Attenuates the audio output level when it is set to ON.

⑧ **AUDIO OUT jacks (Left/Right) (16, 18)**

Outputs stereo analog audio signals.

⑨ **DIGITAL OUT jack(s) (COAXIAL/OPTICAL) (18)**

Outputs digital audio signals. You must select the signal type correctly according to the external device connected to via the Preference display.

⑩ **~ AC IN connector (19)**

Connects to the wall outlet using the supplied AC power cord.

Operational Principles

On-screen displays

The unit provides several on-screen displays. With some displays, you can set or select preferences or functions, while the others are display-only.

Opening displays

The Opening display appears automatically in some conditions.

At the bottom, the following information are indicated depending on the unit's status.

- NOW READING: The unit is now reading the disc information (TOC).
- REGION CODE ERROR!: The DVD VIDEO disc loaded cannot be played because the region code of the disc does not match the unit.
- CHANGE→DISC 1: The unit is now changing the disc tray to DISC 1.
- OPEN: The disc tray is now opening.
- CLOSE: The disc tray is now closing.

Opening display

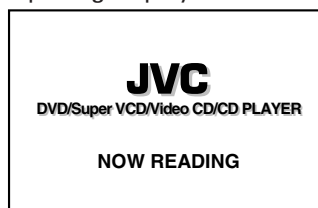

Preference displays

When no disk is inserted or when a DVD VIDEO or Video CD disk is inserted and stopped, pressing the CHOICE button brings up the preference display for setting the preferences.

There are four pages: LANGUAGE, AUDIO, DISPLAY and SYSTEM as shown on the right.

See page 53 for detailed information.

LANGUAGE

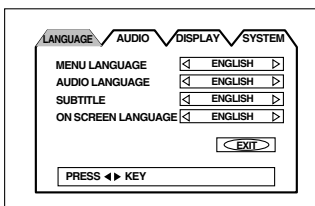

AUDIO

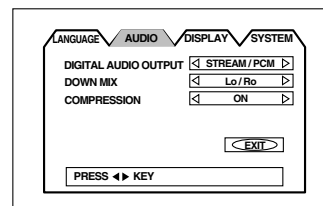

DISPLAY

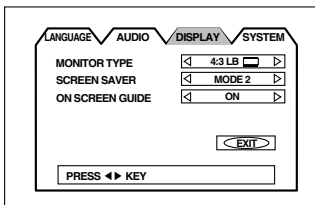

SYSTEM

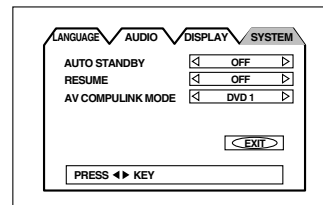

PARENTAL LOCK display

When no disc is inserted or a DVD VIDEO disc is stopped, pressing the ENTER button while holding down the ■ button brings up the PARENTAL LOCK display in which you can set the level for limiting playback. See page 57 for detailed information.

PARENTAL LOCK

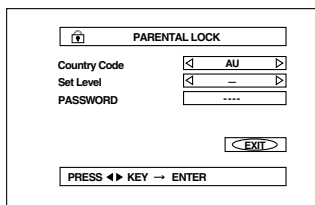

Play mode displays

Pressing the PLAY MODE button brings up the play mode display in which you can control playback functions.

Different displays appear depending on the disc type and the unit's status.

While stopped

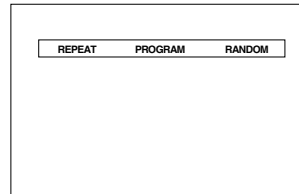

During DVD VIDEO playback

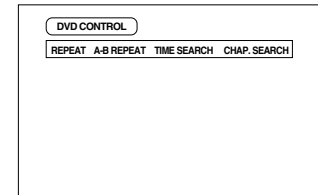

During Audio CD/MP3 disc playback

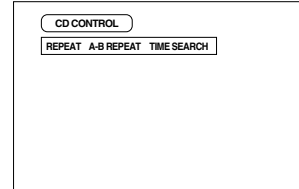

During Video CD/SVCD playback

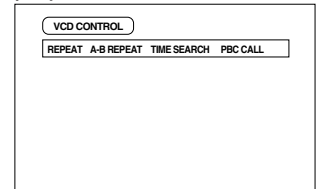

Status displays

Pressing the DISPLAY button during playback brings up the status display.

For a DVD VIDEO disc, pressing the DISPLAY button toggles between the DVD VIDEO function status display, the disc/time display and off.

For a Video CD, SVCD, Audio CD or MP3 disc, pressing the DISPLAY button switches the disc/time display on and off.

DVD VIDEO function status

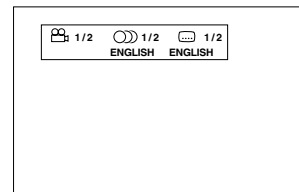

Disc/time (DVD VIDEO)

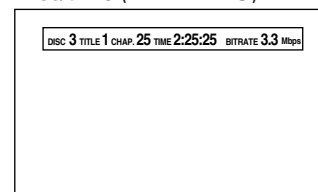

Disc/time (Audio CD/Video CD/SVCD without PBC)

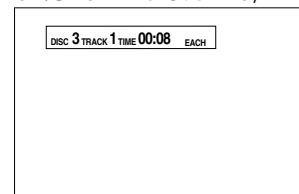

Disc/time (Video CD/SVCD with PBC)

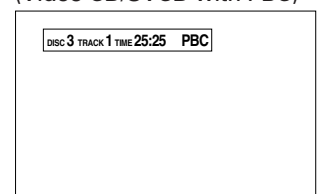

Disc/time (MP3 disc)

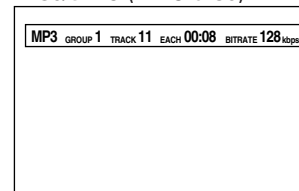

KARAOKE setting displays

When KARAOKE mode is on, pressing the DISPLAY button brings up the KARAOKE menu display in which you can set several KARAOKE functions.

Pressing MENU-RESERVE button while holding down the SHIFT button brings up the KARAOKE reservation display in which you can reserve songs to be played.

KARAOKE menu

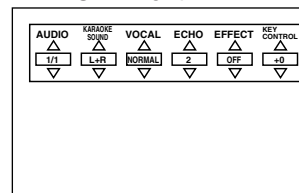

Reservation display

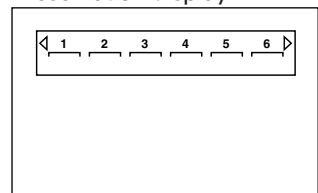

To prevent the monitor from burning out [SCREEN SAVER]

A television monitor screen may be burned out if a static picture is displayed for a long time. To prevent this, the unit automatically activates the screen saver function if a static picture, such as an on-screen display or menu, is displayed for over 5 minutes.

- Pressing any button on the unit or the remote control unit will release the screen saver function and return to the previous display.
- You can select one of several screen saver modes available (see page 56).
- The screen saver function is not activated during Audio CD playback or after stopping Audio CD playback.

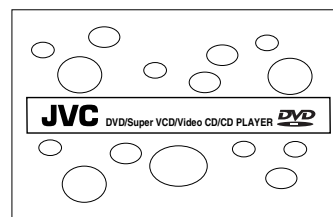

On-screen guide icons

During DVD VIDEO playback, you may see icons displayed over the picture. These have the following meanings.



: Displayed at the beginning of a scene recorded from multiple angles. (See page 36.)





: Displayed at the beginning of a scene recorded with multiple audio languages. (See page 38.)



: Displayed at the beginning of a scene recorded with multiple subtitle languages. (See page 37.)

You can set the unit not to display on-screen icons above via the preference settings described on page 56.

About invalid operation icon

When you press a button, if the unit does not accept its operation,  appears on your television screen. Operations are occasionally unacceptable even if  is not displayed.

Note that some operations may not be accepted. For example, some discs may not allow rapid advance/reverse or slow-motion playback.

How to use numeric buttons

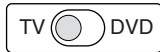

The function of the numeric buttons differs depending on the setting of the TV - DVD switch. When setting it to TV, the buttons are used to select a TV channel (see page 21). When setting it to DVD, the buttons are used to select a track/title/group or enter a disc time or chapter number.

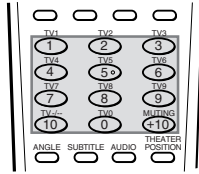

To select a track/title number

- **To select a number between 1 and 10**
Press the corresponding button for the number.
- **To select a number higher than 10**
Use the +10 button.

Examples:

To select 13 +10 → 3
 To select 34 +10 → +10 → +10 → 4
 To select 40 +10 → +10 → +10 → 10

To enter a time or chapter number

The method for entering a time for Time search or chapter number for Chapter search is different from above. See the corresponding sections in this manual for the details.

* There is another method for selecting a track or group of an MP3 disc. See the appropriate section.

About discs

Playable disc types

Playable and non-playable disc types are as follows:

Playable discs

DVD VIDEO 	Video CD  	SVCD  	Audio CD 
--	---	---	--

The DVD VIDEO Logo is a trademark.

- CD-R and CD-RW discs recorded with the Audio CD or MP3 format can be played back, though some may not be played back because of the disc characteristics or recording condition.
- DVD VIDEO players and DVD discs have their own Region Code numbers. This unit only can play back DVD VIDEO discs whose Region Code numbers include "4."

Examples of playable DVD VIDEO discs:



Non-playable discs

DVD-ROM, DVD-RAM, DVD AUDIO, DVD-R, DVD-RW, CD-ROM, PHOTO CD, CD-EXTRA, CD-G, CD-TEXT

- Playing back discs listed as "Non-playable discs" above may generate noise and damage speakers.
- This unit can play back audio recorded in CD-G, CD-EXTRA and CD-TEXT discs.

Disc structure

A DVD VIDEO disc is comprised of "titles," while an Audio CD, Video CD or SVCD is comprised of "tracks." Each title may be divided into some "chapters." For example, if a DVD VIDEO disc contains some movies, each movie may have its own title number, and each movie may be divided into some chapters. In a DVD VIDEO KARAOKE disc, each song usually has its own title number and does not have chapters. In general, each title has independent content, while each chapter in the same title has continuity.

(Example: DVD VIDEO disc)

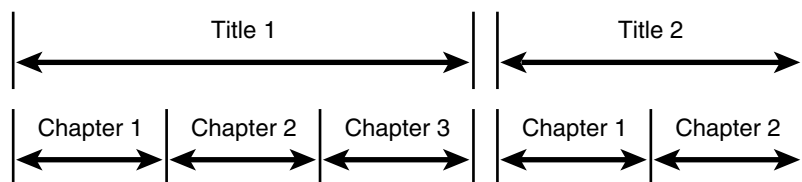

(Example: Audio CD/Video CD/SVCD)

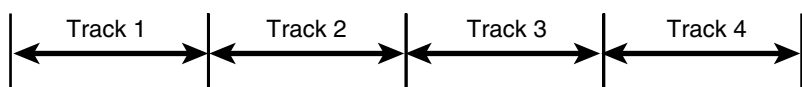

Connections

*In the following description, "TV" may be substituted with "monitor" or "projector."

*Before using the unit, you have to connect the unit to a TV and/or amplifier.

Before making any connections

- Do not connect the AC power cord until all other connections have been made.
- Since different components often have different terminal names, carefully read the instructions supplied with the component you are going to connect.

To connect to a TV

You can enjoy using the unit by simply connecting it to a TV. To improve audio sound quality, connect the audio outputs to your separate audio equipment. (See the following pages.)

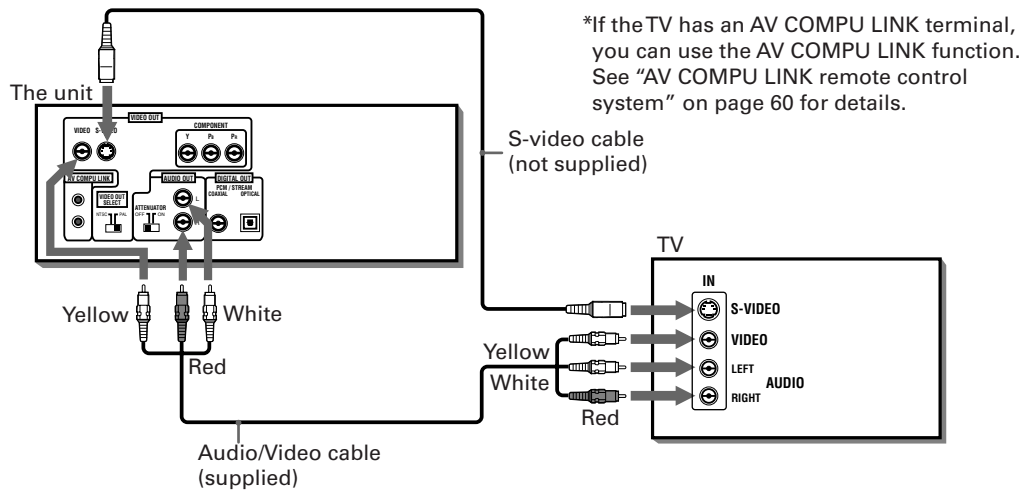

Connect the unit to a TV equipped with stereo audio input and video input jacks using the supplied audio/video cables.

- If your TV has a monaural audio input instead of stereo, you need to use an optional audio cable which converts stereo audio output to monaural.
- If your TV has an S-video input, you should connect it with the S-VIDEO output of the unit using the optional S-video cable in addition to the (standard) video connection to get better picture quality.

Set the ATTENUATOR switch to OFF normally. If you hear audio sound distorted because the sensitivity of the audio input of your TV is too high, set the switch to ON.

The unit is compatible with the PAL and NTSC systems, Set the VIDEO OUT SELECT switch on the rear panel to match the color system of your TV. Make sure that the color system of a DVD VIDEO/Video CD/SVCD disc labeled on the package matches your TV. If you use a multi-system TV, you can play discs recorded on both PAL and NTSC systems by setting the VIDEO OUT SELECT switch appropriately. However, note that you must change the switch position while the unit power is off (standby). Otherwise, the changed setting is not effective.

NOTE

- Connect VIDEO OUT of the unit directly to the video input of your TV. Connecting VIDEO OUT of the unit to a TV via a VCR may cause a monitor problem when playing back a copy-protected disc.

To connect to a TV with the component video input jacks

You can enjoy high picture quality by connecting the unit's COMPONENT VIDEO OUT jacks to the COMPONENT VIDEO IN jacks of your TV with the video cables.

Note that the COMPONENT VIDEO OUT jacks are not active in the initial (factory preset) condition. See below for details how to make them active.

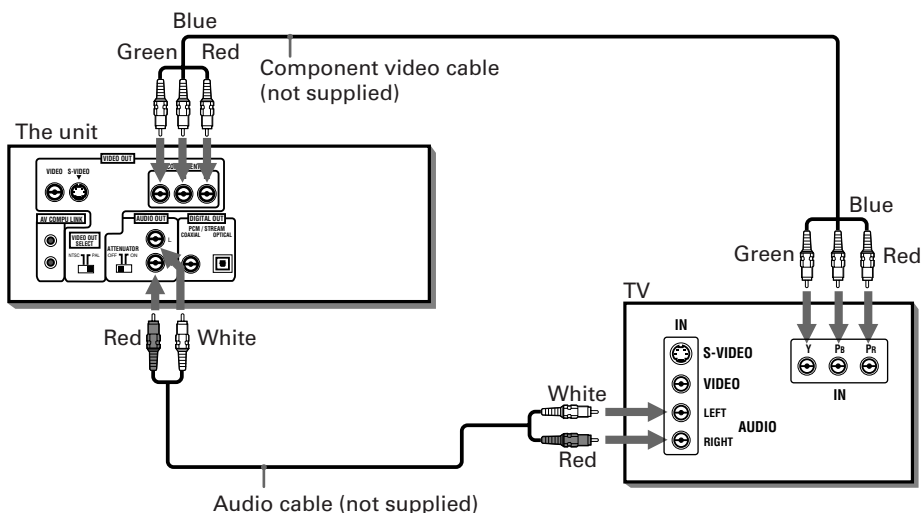

- Connect "Y" to "Y," "PB" to "PB," "PR" to "PR" correctly.

NOTE

- When the component video input jacks of the TV is of the BNC type, use an adapter to convert a pin jack to a BNC jack (optional).

How to make the COMPONENT VIDEO OUT jacks active

Either the COMPONENT VIDEO OUT jacks or the S-VIDEO jack can be active. In the initial (factory preset) condition, the S-VIDEO jack is active while the COMPONENT VIDEO OUT jacks are not active.

To change the active jack(s) from the initial S-VIDEO to COMPONENT VIDEO, use the following procedure.

■ when the unit is turned on

- 1 Press and hold down the ■ (STOP) button on the front panel when no disc is inserted or while the unit is stopped. "S out" (the current setting) appears in the display window after a few seconds.

(Display window)

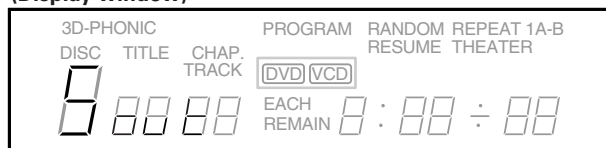

- 2 Keep holding down the ■ (STOP) button on the front panel. After a few more seconds, "C out" replaces "S out" in the display window. Now the COMPONENT VIDEO jacks are active and the S-VIDEO jack is not active.

(Display window)

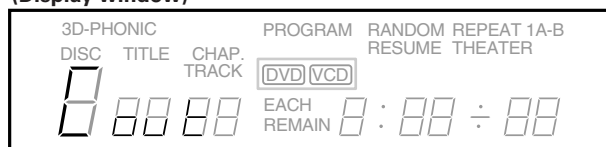

- To change the active jack(s) from the COMPONENT VIDEO to the S-VIDEO jack, use the similar procedure.

To connect to an audio amplifier or receiver

You can enjoy high-quality audio by connecting the unit's audio output to your amplifier or receiver.

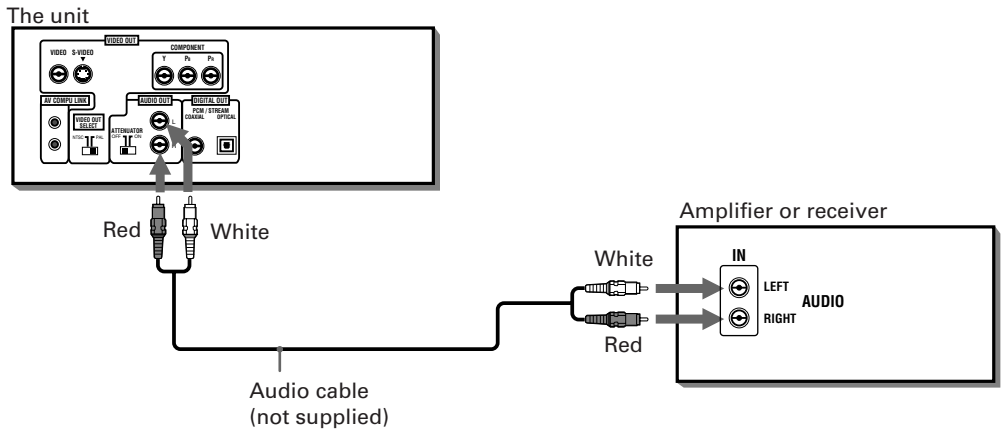

- Connect the unit's AUDIO OUT to any line-level inputs (such as AUX, DVD, CD, etc.) of an audio amplifier or receiver.

To connect to audio equipment with a digital input

You can enhance the sound quality by connecting either of the unit's DIGITAL OUT jacks (OPTICAL or COAXIAL) to the digital input of an amplifier, MD, etc. by using an optional digital cable. The digital audio signal from a disc is directly transferred. If you connect the unit to a Dolby Digital or DTS decoder or an amplifier with a built-in decoder by using an optional digital cable, you can enjoy high-quality surround sound. When you make the digital connection, we recommend also to make the analog connection, because, depending on discs, no signal may be output from the DIGITAL OUT.

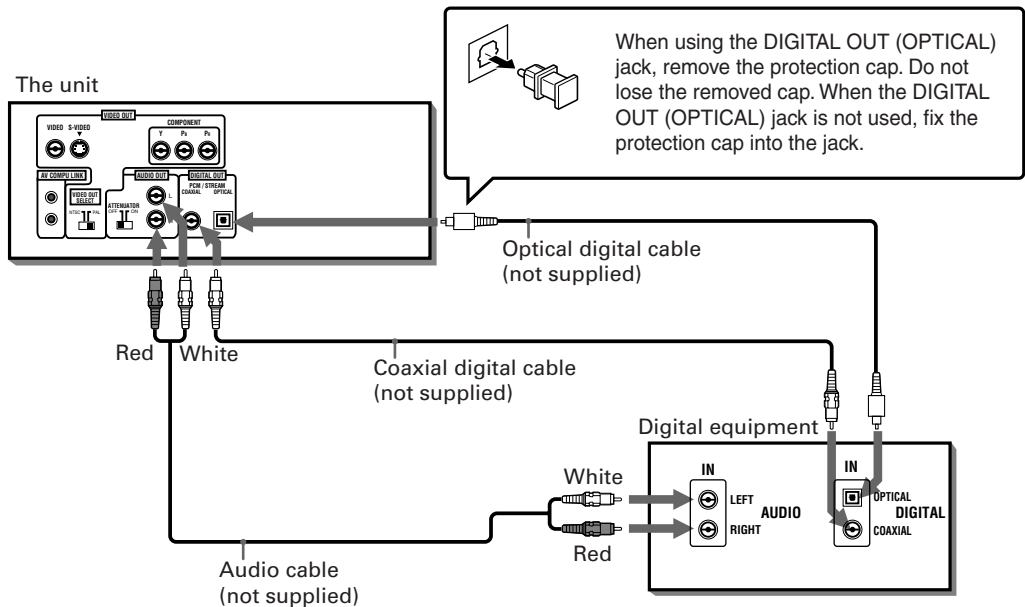

NOTES

- When you connect the unit's DIGITAL OUT to digital audio equipment, before using, make the "DIGITAL AUDIO OUTPUT" setting in the "AUDIO" page of the preference display correctly according to the connected audio equipment. If the "DIGITAL AUDIO OUTPUT" is not set correctly, loud noise may be generated from speakers, causing damage to your speakers. See "DIGITAL AUDIO OUTPUT" on page 54.
- With the digital connection, the COMPRESSION setting in the AUDIO page of the preference display are invalid. Settings for these items must be made from the decoder.

To connect the power cord

English

When all the audio/video connections have been made, insert the smaller plug of the supplied AC power cord to the unit's AC IN connector, then insert the other end to the wall outlet. Make sure that plugs are inserted firmly. The STANDBY indicator lights and setup is completed.

Warning

- Disconnect the power cord if you are not going to use the unit for a long time.
- Disconnect the power cord before cleaning the unit.
- Disconnect the power cord before moving the unit.
- Do not connect or disconnect the power cord with wet hands.
- Do not pull the power cord when disconnecting it, as this may damage the cord and cause fire, electric shock, or other accidents.

Caution

- Do not damage, alter, twist, or pull the power cord, as this may cause fire, electric shock, or other accidents.
- To prevent any accidents or damages caused by an unsuitable AC power cord, only use the supplied power cord. If the cord is damaged, contact a dealer and get the new power cord.
- Do not put anything heavy, or the unit, on the power cord, as this may cause fire, electric shock, or other accidents.

Getting started

Using the remote control unit

Using the remote control, you can operate not only all the functions of the unit but also basic functions of your TV.

To install batteries in the remote control unit

The battery compartment is located on the back of the remote control unit.

1 Press down on the point shown by the arrow at the top of the compartment cover, and pull up the cover to open the compartment.

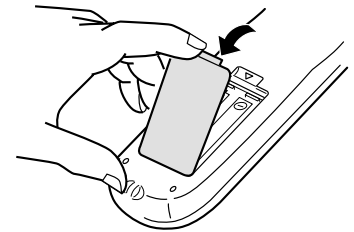

2 Place the two accessory R6P (SUM-3)/AA(15F) batteries in the remote control according to the polarity markings (“+” and “-”) inside the compartment and on the batteries.

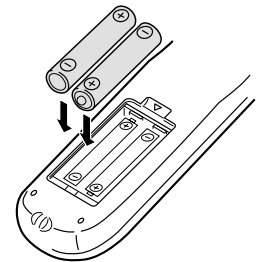

3 Place the cover over the compartment, and press down lightly.

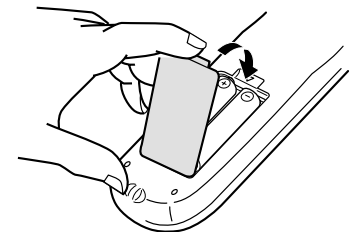

- The batteries will last about six months with normal use. If the functions of the remote control become erratic, replace the batteries. See below for more information.

Precautions for the safe use of batteries

Observe the following precautions for the safe use of batteries. If they are used improperly their life will be shortened, they may burst or their contents may leak.

Precaution

- Remove the batteries from the remote control if it is not going to be used for a long period of time.
- Remove dead batteries and dispose of them properly.
- Never leave dead batteries lying around, take them apart, mix them with other refuse, or throw them into an incinerator.
- Never touch liquid that has leaked out of a battery.
- Do not mix new and old batteries, or batteries of different types, when replacing them.

To use the remote control unit for TV operation

You can operate your TV from the remote control unit.

Setting the remote control signal for operating your TV.

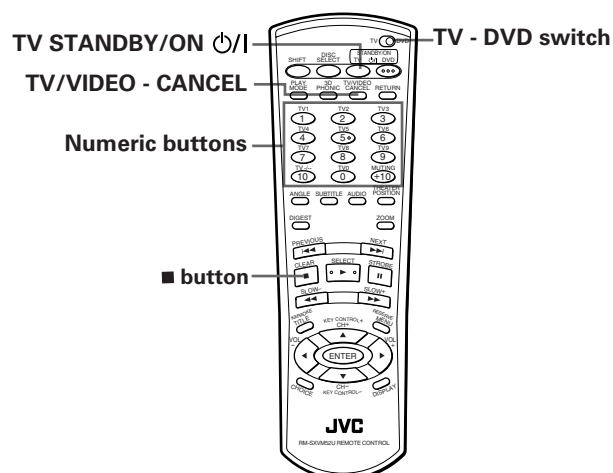

- 1 Holding down TV/VIDEO - CANCEL, enter the manufacturer code of your TV listed below by using the numeric buttons (0 to 9).
Do not release TV/VIDEO - CANCEL. Keep holding it until the next step is completed.

Example:

To enter the manufacturer code "01": Press "0" then "1".

- 2 Press ■ while holding down TV/VIDEO - CANCEL.
- 3 Try to operate your TV by pressing TV STANDBY/ON (power).
If your TV turns on or off, you have successfully set the control signal.

Manufacturer code list

No.	Manufacturer
01	JVC
02	PHILIPS/CCE/MAGNAVOX
03	MITSUBISHI
04	PANASONIC
05	RCA
06	SHARP
07	SONY
08	TOSHIBA
09	ZENITH
10	PHILCO/HITACHI
11	PANASONIC
12	SAMSUNG
13	SANYO/SEARS
14	TOSHIBA

No.	Manufacturer
15	GRADIENTE
16	SANYO
17	PHILCO/DAEWOO
18	LG (GOLDSTAR)
19	GRUNDIG
20	NEC/GRADIENTE
21	PHILCO
22	BEIJING/NOBLEX
23	JVC (ONWA)
24	JVC (ONWA)
25	JVC (ONWA)
26	THOMSON
27	FERGUSON
28	ITT

No.	Manufacturer
29	MIVAR
30	FINLUX
31	NOKIA
32	FUNAI
33	SAMSUNG
34	SAMSUNG/PEONY/CHANGHONG
35	SAMSUNG
36	AIWA
37	DAEWOO
38	JINXING/PEONY
39	PEONY
40	KONKA
41	TCL

The following buttons can be used for operating the TV:

To use the CURSOR (CH-, CH+, VOL-, VOL+), TV/VIDEO - CANCEL and numeric buttons for TV control, set the TV - DVD switch to "TV":

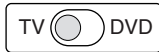



	Turns the TV on or off.
	Switches the TV input mode between TV and VIDEO.
	Selects the TV channels directry. *For some TVs, pressing "+10" functions as the "100+," while "10" functions as the ENTER button if your TV requires pressing the Enter button after selecting a channel number.
	Mutes the TV sound.
	Changes the TV channels.
	Adjusts the TV volume.

NOTES

- The remote control unit is initially set operating a JVC TV.
- If there is more than one code listed for the manufacturer of your TV, try them one by one until you succeed.

In the following description, the buttons on the remote control unit are mainly used, however, you may use the corresponding buttons on the front panel of the unit if available.

Turning on/off the unit

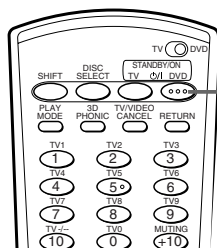

Press DVD STANDBY/ON  on the remote control unit or press  on the front panel.



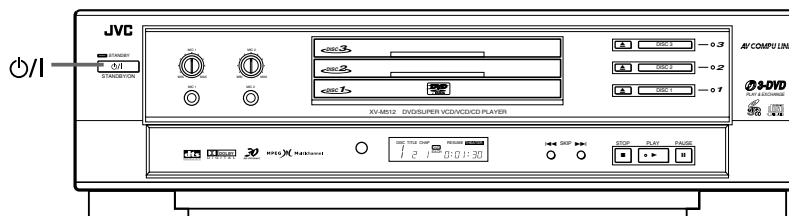

DVD STANDBY/ON

Hints

- You can turn on the unit by pressing the  button or any one of the DISC (1 through 3) buttons on the front panel. In this case, the unit starts playback if the disc is set in the disc tray.
- If no disc is set, "NO DISC" appears on the display window.
- You can turn on the unit by pressing the  (Open/Close) button on the front panel.

NOTE

- Even if you press the DVD STANDBY/ON  or  button to turn off the unit, the unit is not disconnected from the AC power source as long as it is connected to the wall outlet. This state is called the standby mode. In this state, the unit consumes a very small amount of power.

Inserting and removing discs

1 Press  (Open/Close) located on the right of the disc tray you want to open.

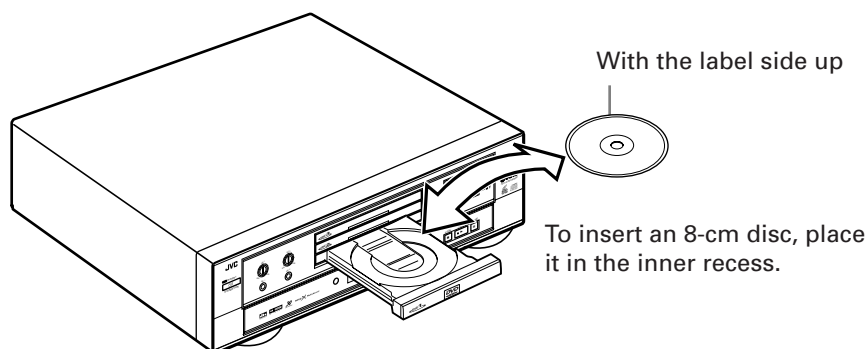

The corresponding disc tray opens.

2 Place the disc in the tray.



3 Press  (Open/Close) located on the right of the disc tray.

Hints

- If you press  (Open/Close) during playback, the unit stops playback and opens the tray.
- You can insert or remove the disc by pressing  (Open/Close) for a disc tray which is not in use for playback while a disc in the other tray is being played, without interrupting playback.

NOTES

- The unit can playback DVD VIDEO, Audio CD, Video CD, SVCD and MP3 discs only. Do not load other disc types. For details about playable disc types, see page 15.
- When loading a disc in the tray, be sure to position the disc inside the recess. Otherwise, the disc may be damaged when the tray is closed, or the disc may not be removed from the unit.

Basic playback

Now you can play a disc. First, let's enjoy simple playback using a DVD VIDEO, Audio CD, Video CD or SVCD disc according to the following procedure. For basic operations with an MP3 disc, see pages 42.

To start playback



Method 1

Press ► on the front panel or remote control unit.

The unit starts playback from the selected disc indicated in the display window.

Method 2

Press any of the DISC (1 through 3) buttons on the front panel.

The unit starts playback of the disc corresponding to the DISC button you pressed.

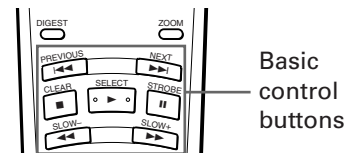

Basic control buttons

Method 3

Press DISC SELECT and any of numeric (1 through 3) buttons on the remote control unit.

The unit starts playback of the disc corresponding to the numeric button you pressed.

In any cases above, the unit basically plays back all discs in the trays once continuously in the following sequence and then stops.



- The unit changes the playback disc when the current disc finishes and stops playback. Therefore, if the current disc is a DVD VIDEO disc, Video CD disc or SVCD disc with PBC function, it may not finish playback and the unit may not change the disc and playback the next disc.

NOTES

- When the resume point is memorized, pressing ► starts playback from that point instead of the beginning. See page 26 and 56.
- During playback, the display window shows the disc number or the title/chapter or track number being played.
- With Video CD or SVCD discs with PBC control or some DVD discs, the menu display may appear on the TV screen after starting playback. In such a case, select an item to be played back from the menu. For operation using a menu, see page 27.
- With some DVD discs, the unit starts playback automatically after inserting the disc.

To stop playback completely



Press ■.

The unit stops playback.

To stop playback temporarily



Press II.

The unit pauses playback. To resume playback, press ►.

To advance or reverse playback rapidly while monitoring



English

- During playback

From the Remote control unit

Press ◀◀ or ▶▶.

Each press of ◀◀ or ▶▶ increases the playback speed. You can select the speed among 2x, 5x, 10x, 20x and 60x the normal speed.

Pressing ▶ returns the unit to normal playback.

From the Front panel

Hold down ◀◀◀ or ▶▶▶.

Holding down ▶▶▶ advances playback rapidly, while holding down ◀◀◀ reverses playback rapidly. The speed will change from 5x to 20x the normal speed if you keep holding down the button for a certain period of time. Releasing the button returns the unit to normal playback.

To locate the beginning of the scene or song



- During playback

Press ◀◀◀ or ▶▶▶.

Press ◀◀◀ to locate the beginning of the current chapter, title, or track, and press ▶▶▶ to locate the beginning of the next chapter, title, or track.

NOTE

- When you play a Video CD/SVCD disc with the PBC function or a DVD VIDEO disc, the unit may locate a different place, but it will generally locate the beginning of the title, chapter or track.

Resuming playback

The unit can memorize the position on a disc where you interrupt playback, and resume playback from that position later.

To memorize the interrupted position



- 1 Set the “RESUME” setting on the “SYSTEM” page of the preference display to “ON”.
(See page 56 for details about how to set.)
- 2 At the position you want to interrupt playback, press ■, or press DVD STANDBY/ON on the remote control or on the front panel.
The unit memorizes the interrupted position.



- If you interrupt playback by pressing ■ in step 2 above and then turn off the power, the memory is not cleared.

To resume playback



- While the disc you interrupt playback last time is still in the disc tray.

Press ►.

The unit starts playback from the position where you interrupted playback last time.

- **To clear the resume position memory**

Carry out one of the followings.

- *Take out the disc from the tray.
- *Press any one of the DISC (1 through 3) buttons on the front panel.
- *Press ■ while stopped.
- *Turn on the unit by pressing DVD STANDBY/ON (on the remote control) or (on the front panel).

NOTES

- The resume function does not work with Audio CD and MP3 discs.
- The resume function does not work if “RESUME” on the “SYSTEM” page of the preference display is set to “OFF”.
- In the case of a Video CD/SVCD disc with PBC function, the unit may resume playback from a point slightly earlier than the resume point you stored.
- The resume function does not work in the program or random mode.

In this section, we describe advanced operations for playback of a DVD VIDEO, Audio CD, Video CD or SVCD disc. For operations with an MP3 disc, see pages 42 and 43.

- When you use the functions described below while stopped, make sure that the desired disc number is selected (the selected disc number is shown in the display window). If it is not selected, press the appropriate DISC (1 - 3) button to start playback and then press ■.
- When controlling the unit using the CURSOR, TV/VIDEO - CANCEL or numeric buttons, make sure that the TV - DVD switch is set to "DVD":

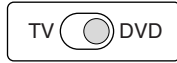

Playing from a specific position on a disc

You can play a disc from the selected track, title or chapter, or from the specified time.

To locate a desired scene from the DVD menu



DVD VIDEO discs generally have their own menus which show the disc contents. These menus contain various items such as titles of a movie, names of songs, or artist information, and display them on the TV screen. You can locate a desired scene by using the menu.

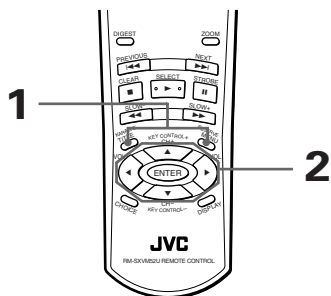

- Whenever a DVD VIDEO disc is loaded

1 Press TITLE or MENU.

The menu appears on the TV screen.



About menu

Normally, a DVD VIDEO disc which contains more than one title may have a "title" menu which lists the titles. In this case, the menu appears on the TV screen by pressing the TITLE button. Some DVD VIDEO discs may also have a different menu which appears by pressing the MENU button.

Example:

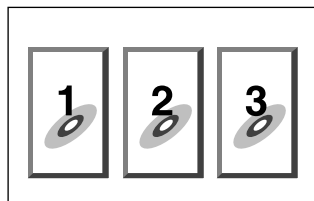

See the instructions of each DVD VIDEO disc for its particular menu.

2 Use CURSOR ▲/▼/◀/▶ to select a desired item, then press ENTER.

The unit starts playback of the selected item.



- With some discs, you can also select items by entering the corresponding number using the numeric buttons, which may cause the unit to automatically start playback.

NOTES

- When ⊙ appears on the TV screen by pressing TITLE in step 1:
The disc does not have a menu listing the titles.
- When ⊙ appears on the TV screen by pressing MENU in step 1:
The disc does not have a menu.
- The menu button does not work while stopped.

To locate a desired scene from the menu of the Video CD/SVCD with PBC



Some Video CD/SVCD discs supports the PBC function. PBC is an abbreviation of "PlayBack Control." A Video CD/SVCD disc recorded with PBC has its own menus, such as a list of the songs of the disc. You can locate a specific scene by using the menu.

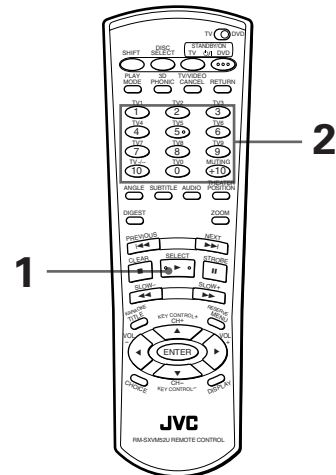

- When a Video CD/SVCD disc with PBC is stopped

1 Press ► (or the appropriate DISC (1 - 3) button on the front panel).

A disc menu appears on the TV screen (The PBC function is activated).

Example:

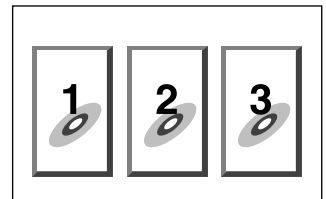

"Pbc" is indicated in the display window on the front panel.

2 Use the numeric buttons to select the desired number of the item.

- See page 14 for details about how to use the numeric buttons.

The unit starts playback of the selected item. You can return to the menu by pressing the RETURN button.

When "NEXT" or "PREVIOUS" appears on the TV screen, the unit generally works as follows:

- Pressing ►► advances to the next page.
- Pressing ◀◀ returns to the previous page.

* The method of the operation is different depending on the disc.

Hints

- To activate the PBC function when a PBC-compatible Video CD/SVCD disc is being played back without the PBC function, press ■ then press ►.
- You can also activate the PBC function using the play mode menu display as follows.
 - 1 Press PLAY MODE.
 - 2 Use CURSOR ◀▶ to move ⏏ to [PBC CALL], then press ENTER.
- If you want to playback a PBC-compatible Video CD/SVCD disc without activating the PBC function, start playback by using the numeric buttons instead of the ► button. See the next paragraph.

To locate a desired selection using the numeric buttons



You can play a desired title or chapter (DVD VIDEO) or track (Audio CD/Video CD/SVCD) by specifying the number.

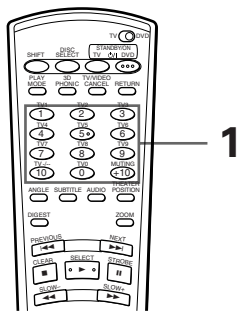

- For DVD VIDEO/Audio CD: During playback or while stopped
- For Video CD/SVCD: During playback without PBC function or while stopped

1 Use the numeric buttons to specify the number.

- * During DVD VIDEO playback (except when a menu is shown), a chapter is specified.
- * While a DVD VIDEO is stopped, a title is specified.
- * For an Audio CD or Video CD/SVCD, a track is specified.

The unit starts playback from the beginning of the selection.

- See page 14 for details about how to use the numeric buttons.

NOTES

- During DVD VIDEO playback, if a menu is shown on the TV screen, the numeric buttons may be used for selecting an item in the menu.
- When Ⓞ appears on the TV screen: The title or track you have selected is not contained in the disc.
- This function does not work during Video CD/SVCD playback with PBC function.

To locate a desired selection using

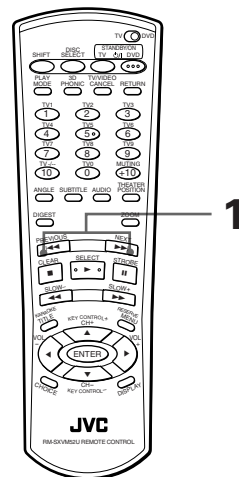

- For DVD VIDEO: During playback
- For Audio CD: During playback
- For Video CD/SVCD: During playback without PBC function

1 Press ◀◀ or ►►.

With an Audio CD, Video CD, or SVCD pressing the button skips a track. With a DVD VIDEO disc, pressing the button skips a chapter or title depending on the disc configuration.

The selection number appears in the display window on the front panel.

- To locate a subsequent selection, press ►► once or repeatedly until the desired selection number appears in the display.
- To locate to beginning of the current selection, press ◀◀ once.
- To locate a former selection, press ◀◀ repeatedly until the desired selection number appears in the display.

NOTES

- This function may not work with some DVD VIDEO discs.
- This function does not work during Video CD/SVCD playback with PBC function.

To locate a desired scene by specifying the chapter number [CHAP.SEARCH]



If the current title of a DVD VIDEO disc being played is divided into chapters, you can skip to a desired chapter by specifying the chapter number using the on-screen display.

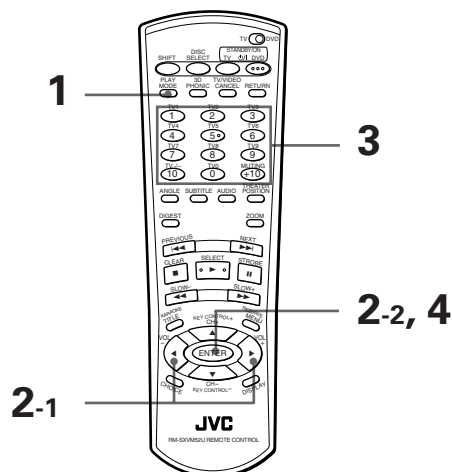

■ During DVD VIDEO playback

1 Press PLAY MODE.

The DVD play mode menu appears on the TV screen.

2 Use CURSOR ◀▶ to move to [CHAP. SEARCH], then press ENTER.

"GO TO CHAPTER =" appears under the menu.

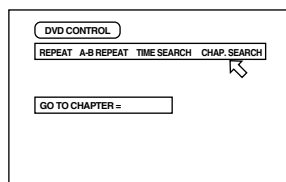

3 Use the numeric buttons (0 to 9) to enter the desired chapter number.

Example:

To select chapter number 8:
Press "8" → ENTER.

To select chapter number 37:
Press "3" → "7" → ENTER.

4 Press ENTER.

The unit starts playback from the selected chapter.



- The "10" and "+10" buttons are not used in this function.

NOTES

- You can also locate a desired chapter directly by specifying the chapter number using the numeric buttons during playback (except when a menu is shown). See page 28.
- When the chapter number is incorrect in step 3:
Overwrite the incorrect number with the correct number.
- When  is displayed in the TV screen in step 4:
The chapter you have selected is not contained in the disc, or chapter search does not work on the disc.
- To turn off the play mode menu:
Press PLAY MODE.

To locate a desired position in the current title or track [TIME SEARCH]



You can play a disc from the desired position by specifying the elapsed time from the beginning of the current title or track using the TIME SEARCH function. Note that some DVD VIDEO discs do not contain time information, and the TIME SEARCH function cannot be used.

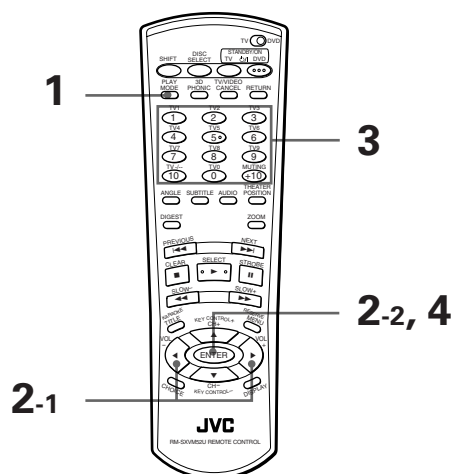

- For DVD VIDEO: During playback
- For Audio CD: During playback
- For Video CD/SVCD: During playback without PBC function

1 Press PLAY MODE.

The play mode menu appears on the TV screen.

2 Use CURSOR ◀▶ to move to [TIME SEARCH], then press ENTER.

"GO TO" appears under the menu.

3 Use the numeric buttons (0 to 9) to enter the time.

You can specify the elapsed time of the current title or track to set the location which you want to playback from.

4 Press ENTER.

The unit starts playback from the specified time.

(for DVD VIDEO)

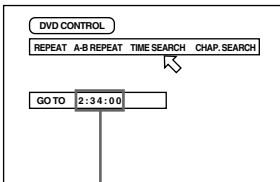

Selected time

(for Audio CD)

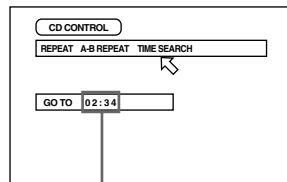

Selected time

Hints

- "10" and "+10" buttons are not used in this function.
- You can specify the time in hour/minute/second format for DVD VIDEO discs, and in minute/second format for Audio CD, Video CD and SVCD discs.

(for Video CD/SVCD)

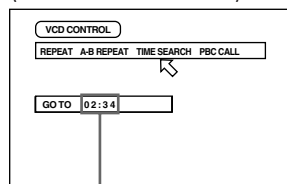

Selected time

Example (for DVD VIDEO)

To playback from 2(H):34(M):00(S)

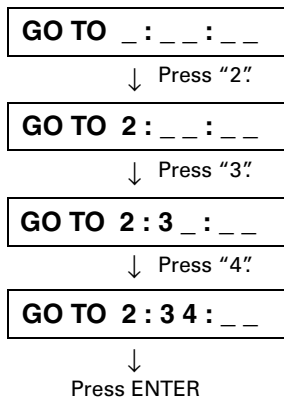

You do not have to press "0" to enter the trailing zeros (for the last two digits in the example above). Of course, it is possible to enter them.

When you make a mistake

Move the cursor to the incorrect value, then press the correct button to re-select the value.

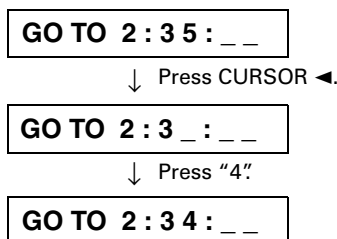

NOTES

- When appears on the TV screen in step 2: The time you have selected is not contained on the disc, or the time search function does not work on the disc. Also note that the time search function does not work during Video CD/SVCD playback with the PBC function.
- To turn off the play mode menu: Press PLAY MODE.
- The TIME SEARCH function cannot be used during program playback.

To locate a desired scene from the display [DIGEST]



The unit can display the opening scene of each title or chapter on a DVD VIDEO or each track of a Video CD/SVCD. You can select a desired scene from those displayed on the TV screen.

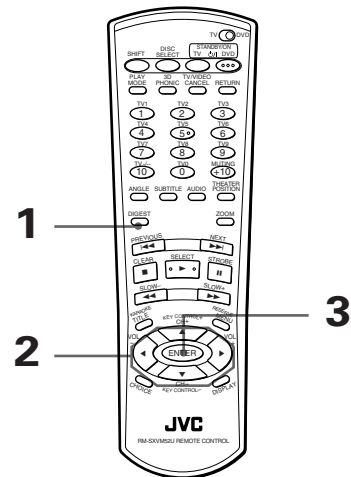

- For DVD VIDEO: While stopped or during playback
- For Video CD/SVCD: While stopped or during playback without PBC function

1 Press DIGEST.

Up to nine opening scenes are displayed.

- While a DVD VIDEO disc is stopped: The opening scene of each title appears on the TV screen.
- During DVD VIDEO disc playback: The opening scene of each chapter in the current title appears on the TV screen.
- When a Video CD/SVCD disc is loaded: The opening scene of each track appears on the TV screen.



2 Use CURSOR ▲/▼/◀/▶ to select the desired scene.

The selected scene is indicated by .

If there are more than 9 scenes, the digest screen will have more than one page. In this case, pressing **▶▶** advances to the next page, while pressing **◀◀** returns to the previous page.



Selected scene

Hints

- When the lower right scene is selected, pressing CURSOR **▶** advances to the next page if available. Similarly, when the upper left scene is selected, pressing CURSOR **◀** returns to the previous page (if available).
- When there are more than one digest page, after pressing DIGEST, pressing **▶▶** before all 9 scenes of the first page appear on the TV screen will advance to the next page. Similarly, pressing **◀◀** before all the scenes of the second or latter page appear on the TV screen will return to the previous page.

3 Press ENTER.

The unit starts playback from the selected scene.

NOTE

- With some discs, depending on the contents, it may take some time until all the scenes appear on the screen.

Special picture playback

English

The unit provides special picture playback functions including Frame-by-frame, Strobe, Slow-motion and Zoom.

To advance a still picture frame-by-frame

DVD VIDEO Video CD Super VCD

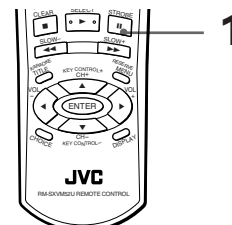

- While paused (still)

1 Press **⏸**.

Each time you press **⏸**, the still picture advances to the next frame.

Pressing **▶** returns to normal playback.

To display continuous still pictures [STROBE]

DVD VIDEO Video CD Super VCD

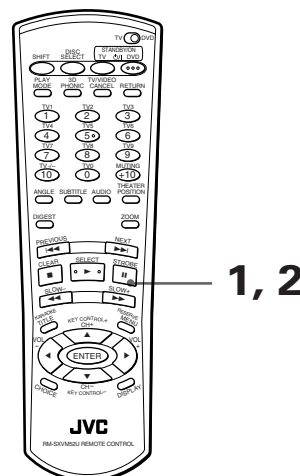

- During playback

1 At the point you want to view as continuous photographs, press **⏸**.

The unit pauses playback.

2 Press and hold **⏸** for more than 1 second.

Nine continuous still pictures appear on the TV screen.

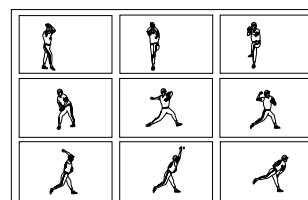

Hints

- Pressing **II** when the nine still pictures is shown will advance to the next nine still pictures.
- Pressing **▶** when the nine still pictures is shown will advance pictures in normal playback speed.
- **To cancel strobe play**
Press and hold **II** for more than 1 second.

NOTE

- If you press and hold **II** for more than 1 second during playback, nine still pictures also appear but they advance in normal playback speed.

To playback in slow-motion [SLOW]

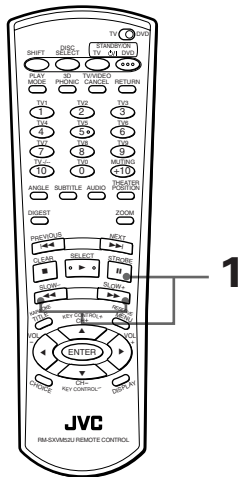

■ During playback

1 Press **II**, then use **◀◀/▶▶**.

To play forward slow-motion, press **▶▶**, and to play reverse slow-motion (for DVD VIDEO discs only), press **◀◀**. First, the unit plays the slowest speed, and each time you press the button, the playback speed increases.

- **To return to normal playback**
Press **▶**.
- **To pause slow-motion playback**
Press **II**.

NOTES

- The sound is muted during slow-motion playback.
- Reverse slow-motion playback is not possible for a Video CD/SVCD.

To zoom a scene [ZOOM]

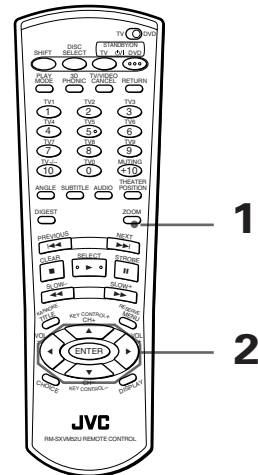

■ During playback or while paused

1 Press ZOOM.

“ZOOM” appears on the TV screen. The unit zooms in to the center part of the scene to produce a double-sized image.

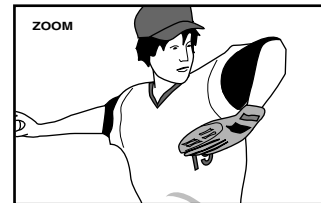
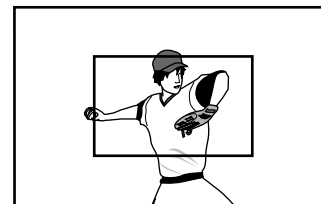

2 Use CURSOR **▲/▼/◀/▶** to move the zoomed-in position.

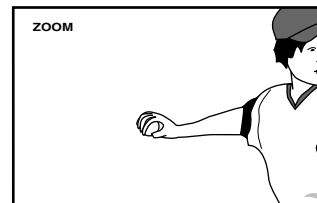

- **To return to normal playback**
Press ZOOM.

NOTE

- While zoomed, the picture may look coarse.

Changing the playback order

You can play titles or tracks on discs inserted in the desired order or in random order.

To playback in the desired order [PROGRAM]



You can play titles or tracks on discs inserted in the desired order by using the Program function.

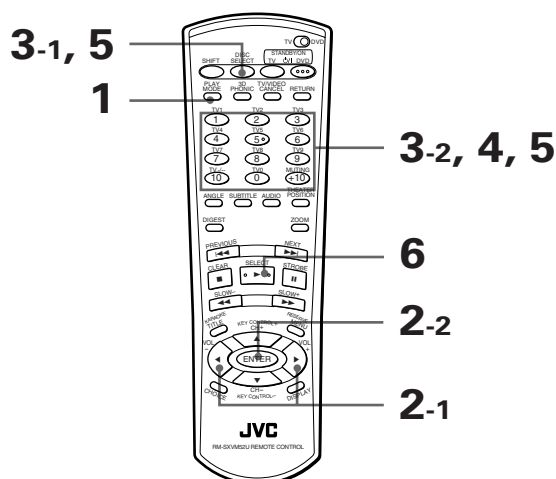

■ While stopped

1 Press PLAY MODE.

The play mode menu appears on the TV screen.

2 Use CURSOR \leftarrow/\rightarrow to move \curvearrowright to [PROGRAM] and press ENTER.

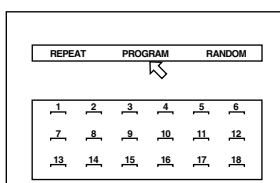

The program table appears under the menu bar (as shown above).

The "PROGRAM" indicator appears in the display window on the front panel.

3 Specify the disc by pressing DISC SELECT followed by the appropriate numeric (1 - 3) button.

4 Specify the titles or tracks in the desired order using the numeric buttons.

See page 14 for details about how to use the numeric buttons.

5 Repeat steps 3 and 4.

Up to 18 titles or tracks can be programmed. You may select the same title or track more than once.

1	2	3	4	5	6
33	25	1-4	28		
7	8	9	10	11	12
13	14	15	16	17	18

The programmed title/track number is shown under each program number.

• If you specify a wrong selection

Press TV/VIDEO - CANCEL. The last selection programmed is erased.

• To clear the program

Press ■.

6 Press \blacktriangleright to start program play.

When all of the programmed titles/tracks have finished playback, the unit stops but the program remains.

• To quit program playback

Press ■ while stopped.

The "PROGRAM" indicator in the display window turns off.

Note that the program remains.

To clear the program, press ■ while the program table is shown on the TV screen.



- While stopped and the play mode menu is displayed on the TV screen, by moving \curvearrowright to [PROGRAM] and pressing ENTER, the program mode quits. Note that the program remains.

NOTES

- Some DVD VIDEO discs may not be played back correctly in program mode.
- During program playback, pressing \blacktriangleright skip to the next selection of the program. Pressing \blacktriangleleft returns to the beginning of the current selection, however, you cannot skip back to the previous selection.
- By pressing PLAY MODE during program playback, the program table is displayed on the TV screen and the current program number is indicated in yellow.
- In the program mode, the DISC (1 through 3) buttons are invalid.

To playback in random order [RANDOM]



You can play titles or tracks on discs inserted in random order by using the Random function.

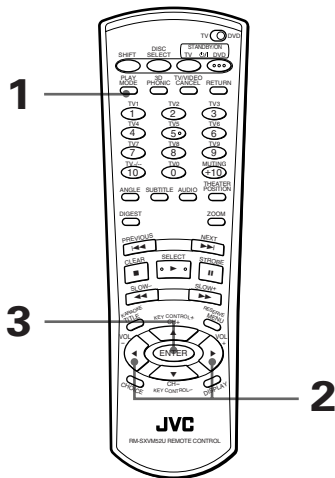

■ While stopped

1 Press PLAY MODE.

The play mode menu appears on the TV screen.

2 Use CURSOR \leftarrow/\rightarrow to move \curvearrowright to [RANDOM].

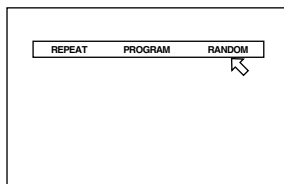

3 Press ENTER.

The "RANDOM" indicator appears in the display window on the front panel.

The unit starts random playback of the selected disc. When all titles/tracks of the disc have been played once, the unit starts random playback of the next disc (if inserted). After playing all titles/tracks of the second disc, the unit starts random playback of the third disc (if inserted). After playing all titles/tracks of all the discs, random playback ends.

Hints

- The same title or track will not be played back more than once during random play.
- **To stop/quit random playback in the middle**
Press \blacksquare to stop playback. The unit is still in random playback mode, so pressing \blacktriangleright starts random playback again.
To quit random playback, press \blacksquare again while stopped. The "RANDOM" indicator in the display window turns off.

NOTE

- Some DVD VIDEO discs may not be played back correctly in the random mode.

Repeat playback

You can repeat playback of the current selection or all disc contents (except DVD VIDEO). You can also repeat playback of a desired part.

To repeat the current selection or all discs contents [REPEAT]

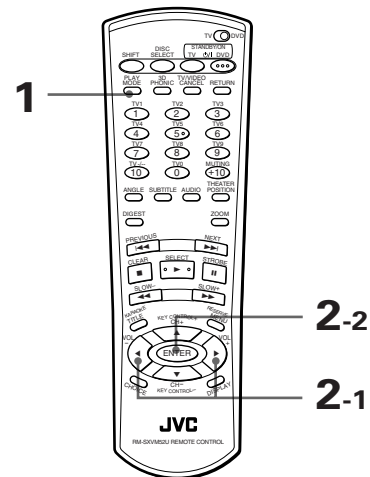

- For DVD VIDEO: During playback
- For Audio CD/Video CD/SVCD: In any condition except Video CD/SVCD playback with PBC

1 Press PLAY MODE.

The play mode menu appears on the TV screen.

2 Use CURSOR \leftarrow/\rightarrow to move \curvearrowright to [REPEAT], then press ENTER.

Each time you press ENTER, the repeat mode changes as follows depending on the disc type and unit's status:

- **During DVD VIDEO playback**

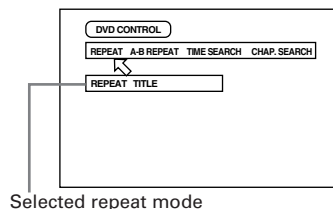

Selected repeat mode

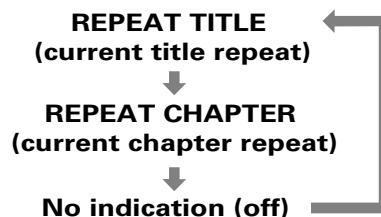

• During Audio CD/Video CD/SVCD playback

(for Audio CD)

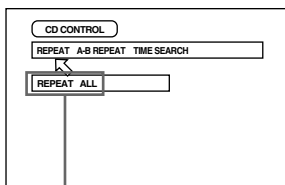

Selected repeat mode

(for Video CD/SVCD)

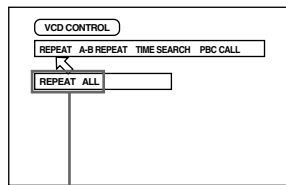

Selected repeat mode

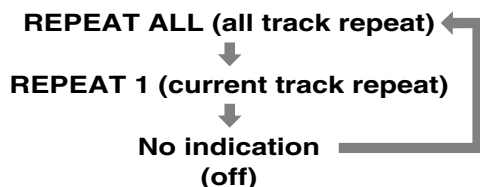

• While Audio CD/Video CD/SVCD stopped

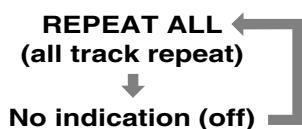

• To stop repeat playback

Press ■.

When a DVD VIDEO disc is set, the unit stops playback and quits the repeat mode.

When an Audio CD, Video CD or SVCD disc is set, the unit stops playback but does not quit the repeat mode.

• To quit repeat playback

With pointed at [REPEAT], press ENTER repeatedly until the mode is set to off.

NOTES

- Some DVD VIDEO discs do not allow the title repeat or and chapter repeat.
- Some DVD VIDEO discs automatically stops playback in the middle of the disc.
- When REPEAT ALL is selected while an Audio CD, Video CD or SVCD is stopped, the unit enters all disc repeat mode and starts playback of the current disc. However, if the unit reads a disc on the second or third tray and recognizes it as a DVD VIDEO disc, the repeat mode is canceled. In other words, you cannot enjoy all disc repeat playback if one or more DVD VIDEO discs are set in the unit.
- During the REPEAT ALL playback, if the next disc is a Video CD/SVCD disc with PBC, the unit plays the disc without activating the PBC function.
- Repeat playback function cannot be used during Video CD/SVCD playback with PBC function.
- To turn off the play mode menu display
Press PLAY MODE.

To repeat a desired part [A-B REPEAT]

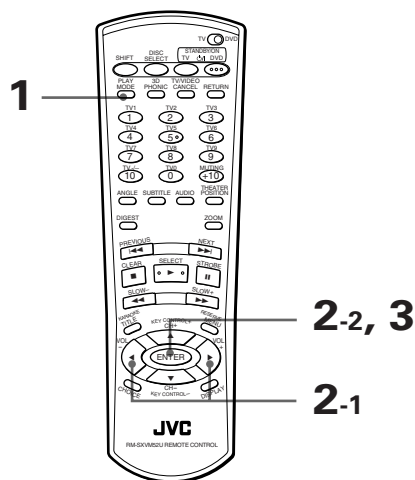

■ During playback

1 Press PLAY MODE.

The play mode menu appears on the TV screen.

2 Use CURSOR to move to [A-B REPEAT], then press ENTER at the beginning of the part you want to repeat (point A).

Make sure that the REPEAT mode is off. If any REPEAT mode is selected, you cannot move to [A-B REPEAT].

3 Press ENTER at the end of the part you want to repeat (point B).

The unit locates "A" and starts repeat playback between "A" and "B."

(for DVD VIDEO)

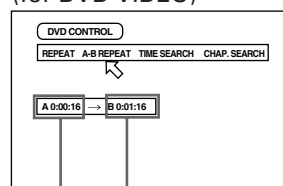

Point A Point B

(for Audio CD)

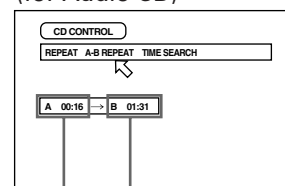

Point A Point B

(for Video CD/SVCD)

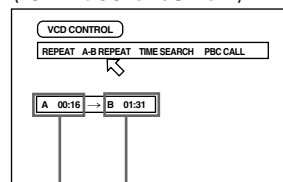

Point A Point B

To quit A-B repeat playback

Press **■**. The unit stops playback and quits A-B repeat mode.

Hints

- During playback, pressing ENTER when  is pointed at [A-B REPEAT] quits A-B repeat mode and continues playback.
- You can also quit A-B repeat mode by pressing **⏮** or **⏭**.

NOTES

- **To turn off the play mode menu**
Press PLAY MODE.
- If  appears when pressing ENTER in step 2 during DVD/SVCD playback
You cannot repeat the selected portion because of the disc contents.
- The A-B REPEAT function cannot be used during program playback.

Selecting a scene angle of DVD VIDEO

You can enjoy a variety of scene angles if the DVD VIDEO disc contains "multi-angle" parts, where multiple cameras were used to shoot the same scene from different angles.

Hints

- At the beginning of a "multi-angle" part,  appears on the TV screen.

To select a scene angle from the normal screen [ANGLE]

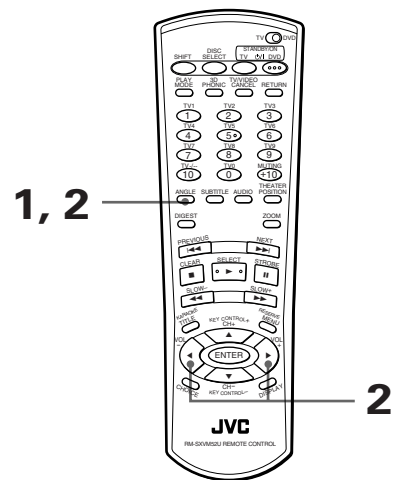

■ During DVD VIDEO playback

1 Press ANGLE.

The Angle selection display appears on the TV screen.

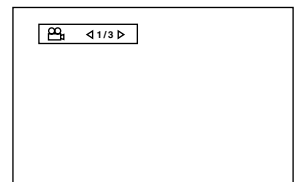

2 Use ANGLE or CURSOR **◀/▶** to select the desired angle.

Each time you press ANGLE or CURSOR **◀/▶**, the angle changes.

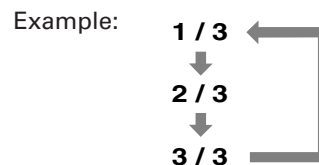

NOTES

- The Angle selection display will automatically disappear if you do not change the angle for 10 seconds.
- To turn off the Angle selection display manually, press ENTER.
- When  appears on the TV screen
The current scene is not recorded from multiple angles.

To select a scene angle from the angle list display [ANGLE]

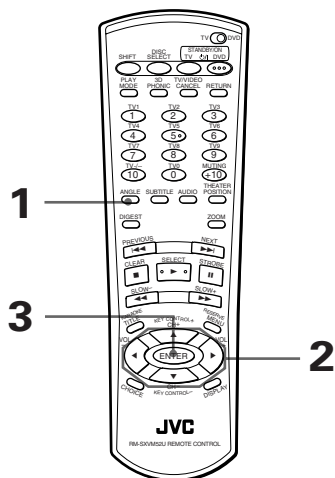

■ During DVD VIDEO playback

1 Press and hold ANGLE for more than 1 second.

Up to nine camera angles recorded on a disc appear on the TV screen.

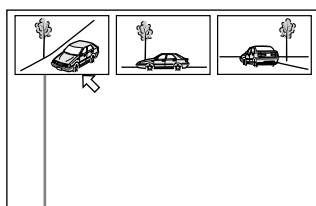

The selected camera angle

2 Use CURSOR \blacktriangle / \blacktriangledown / \blacktriangleleft / \blacktriangleright to select the desired angle.

3 Press ENTER.

The unit starts playback by the selected angle on the full-sized screen.

NOTES

- When \odot appears on the TV screen in step 1: The current scene is not recorded from multiple angles.
- During the operation above, audio is muted.

Changing the language and sound

For DVD VIDEO discs, you can select the subtitle language, as well as the audio language/sound included on a disc. For Video CD/SVCD discs, you can select the audio channel(s).

To select the subtitle language [SUBTITLE]

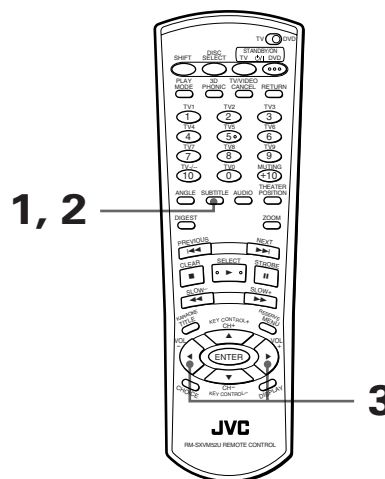

■ During playback

1 Press SUBTITLE.

The Subtitle selection display appears on the TV screen.

(for DVD VIDEO)

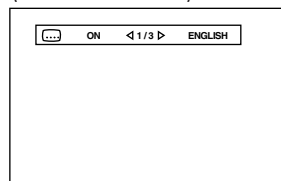

(for SVCD)

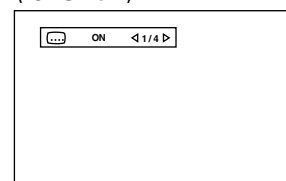

2 To turn the subtitle on and off, press SUBTITLE.

3 To select the desired subtitle language, use CURSOR \blacktriangleleft / \blacktriangleright .

• For DVD VIDEO

Each time you press CURSOR \blacktriangleleft / \blacktriangleright , the subtitle language changes.

Example:

- 1/3 ENGLISH
- ↓
- 2/3 FRENCH
- ↓
- 3/3 SPANISH
- ↓
- /3 (off)

For SVCD

Pressing CURSOR ◀/▶ cycles among the four subtitle channels as follows regardless of whether the subtitle is recorded or not. You can also select the subtitle by pressing SUBTITLE.

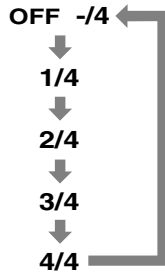

NOTES

- For DVD VIDEO, the selected language may be abbreviated on the TV screen. See "Appendix A: Table of languages and their abbreviations" at the end of this manual.
- The Subtitle selection display will automatically disappear if you do not change the subtitle for 10 seconds.
- To turn off the Subtitle selection display manually, press ENTER.
- When  appears on the TV screen: You cannot select the subtitle.

To change the audio language or sound [AUDIO]



By AUDIO selection, you can choose the audio language of movies or choose to enjoy KARAOKE with or without the vocal.

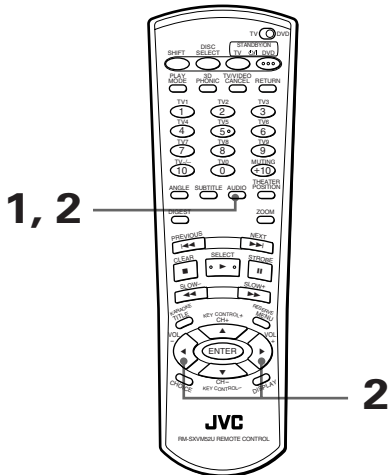

■ During playback

1 Press AUDIO.

The Audio selection display appears on the TV screen.

(for DVD VIDEO)

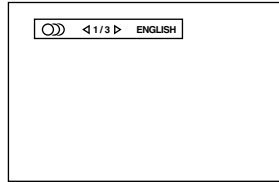

(for Video CD)

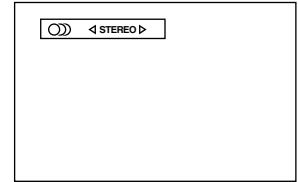

(for SVCD)

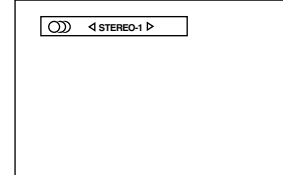

2 Use AUDIO or CURSOR ◀/▶ to select the desired audio.

• For DVD VIDEO

Each time you press AUDIO or CURSOR ◀/▶, the audio language or sound changes.

Example:

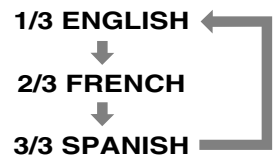

• For Video CD/SVCD

Each time you press AUDIO or CURSOR ◀/▶, the playback audio changes as follows.

(Video CD)

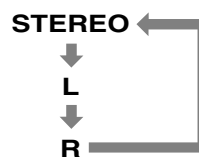

(SVCD)

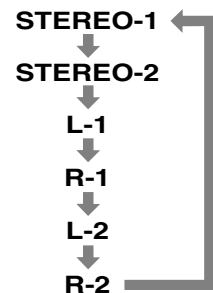

NOTES

- For DVD VIDEO, the selected language may be abbreviated on the TV screen. See "Appendix A: Table of languages and their abbreviations" at the end of this manual.
- The Audio selection display will automatically disappear if you do not change the audio for 10 seconds.
- To turn off the Audio selection display manually, press ENTER.
- When  appears on the TV screen (for a DVD VIDEO disc): You cannot select the audio.

Selecting the picture character

You can select the picture character from among four options according to the source program, lighting condition of the room and/or personal preference.

To select the picture character [THEATER POSITION]

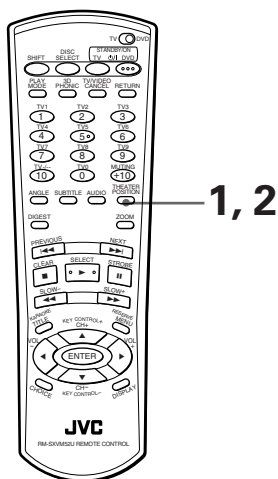

■ During playback

1 Press THEATER POSITION.

The theater position display appears on the TV screen.

2 Select the desired theater position by using THEATER POSITION.

Each time you press the THEATER POSITION button, the picture character changes as follows:



Selected picture character

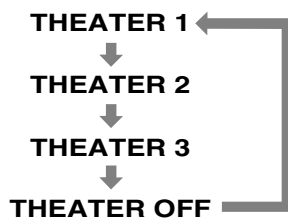

"THEATER OFF" is the normal position. Select a higher number tones down the picture character.

NOTES

- The theater position display will automatically disappear if you do not change the theater position for 5 seconds.
- To turn off the theater position display manually, press ENTER.

Enjoying virtual surround sound

Using the 3D PHONIC function, you can get a simulated surround effect from your stereo system.

To simulate surround sound [3D PHONIC]

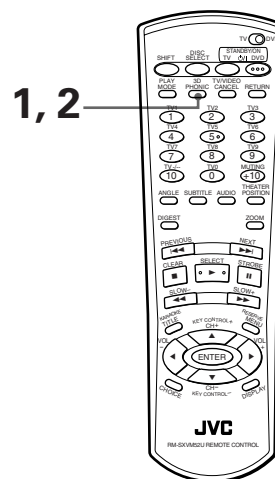

■ During playback

1 Press 3D PHONIC.

The 3D PHONIC display appears on the TV screen.

2 Select the desired mode by using 3D PHONIC.

Each time you press the 3D PHONIC button, the 3D PHONIC mode changes as follows:

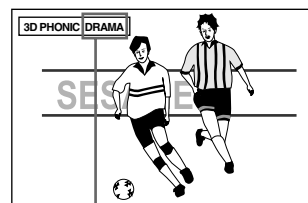

Selected effect mode



• ACTION

Suitable for action movies and sports programs in which sounds dynamically move.

• DRAMA

Natural and warm sound. You can enjoy movies in a relaxed mood.

• THEATER

You can enjoy sound effects like in a major theater in Hollywood.

- * When you play a DVD VIDEO disc recorded in Dolby Digital which contains more than 3 channels, ACTION does not appear.

NOTES

- The 3D PHONIC display will automatically disappear if you do not change the 3D PHONIC for 5 seconds.
- To turn off the 3D PHONIC display manually, press ENTER.
- With a Video CD disc, if the Audio setting is set to L or R, you cannot activate the 3D PHONIC function (i.e the 3D PHONIC mode is fixed to OFF).
Conversely, when the 3D PHONIC function is active, changing the AUDIO setting to L or R from STEREO cancels the 3D PHONIC function.
- The 3D PHONIC function works correctly when playing back discs recorded in the Dolby Surround or Dolby Digital 5.1-CH format.
It also works when playing back discs other than those above, but does not provide the correct effect.
- The 3D PHONIC function does not affect the DTS or Dolby Digital bitstream signal from the DIGITAL OUT jack.
- The sound effect will not be set or operate, even if 3D PHONIC is pressed, for the sound of DVD VIDEO discs recorded in Linear PCM.
- When you set the 3D PHONIC function to on, the DOWN MIX and COMPRESSION settings in the AUDIO page of the preference display are disabled.

Checking the status

You can view the disc/time information, as well as the DVD functions status on the TV screen.

To check the disc/time information

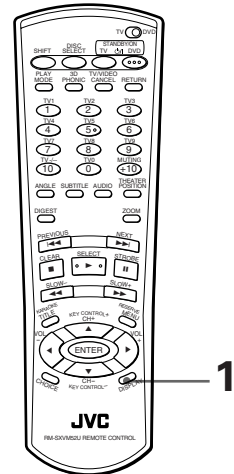

■ During playback

- 1 Press DISPLAY once for a Audio CD, Video CD or SVCD disc, or twice for a DVD VIDEO disc. The disc/time display appears on the TV screen.

(for DVD VIDEO)

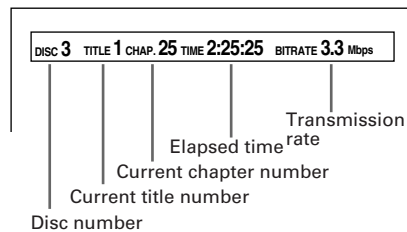

(for Audio CD, Video CD or SVCD playing without PBC)

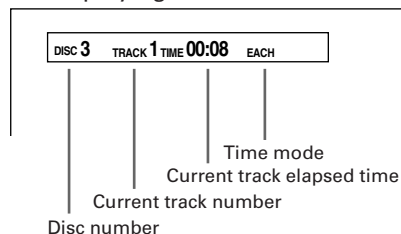

(for Video CD/SVCD playing with PBC)

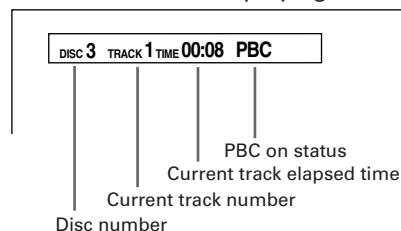

- To turn off the disc/time display Press DISPLAY.

To check the DVD function status

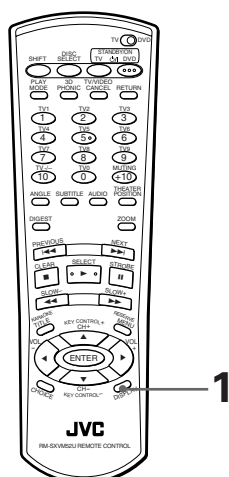

- During DVD VIDEO playback

1 Press DISPLAY.

The DVD function status display appears on the TV screen.

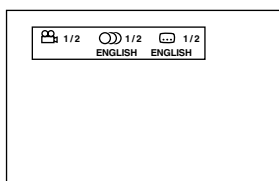

The current selections of the camera angle, audio language and subtitle language are shown.

- **To turn off the DVD function status display**

Press DISPLAY twice.

To dim, the brightness of the display window

English

You can select the brightness of the display window.

Dimming the brightness of the display window

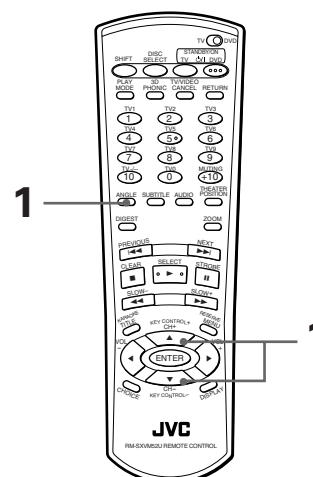

- When no disc is inserted or while stopped

1 Press CURSOR ▼ while holding down ANGLE.

The display window gets darker.

To restore the display window brighter, press CURSOR ▲ while holding down ANGLE.

MP3 disc playback

This unit can playback CD-R/RW discs recorded by the MP3 format (we refer to those discs as MP3 discs in this manual). Operations for MP3 discs are similar to those for Audio CD discs, though there are some restrictions and differences.

What is MP3?

MP3 is the abbreviation of "MPEG1 Audio Layer 3". MPEG Audio is a compression specification that compresses the audio portion only. This image compression method is used in DVD or Video CD, etc. The audio data has been compressed into about 1/10.

About MP3 disc

On an MP3 disc, each material (song) is recorded on each Track (file), which usually belongs to a Group (folder).

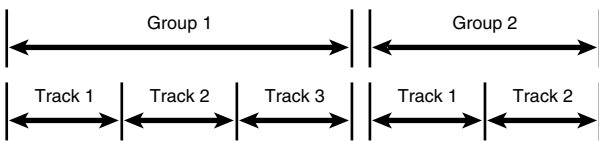

This unit can recognize up to 99 Groups and up to 254 Tracks per Group, however, the number of Tracks to be played back on a disc is limited to 1023.

If a disc includes more than 1023 Tracks, the unit stops detecting Tracks when the number of detected Tracks reaches 1023 and ignores the subsequent Tracks. The unit also ignores any non-MP3 file in the disc.

NOTES for making a private MP3 disc using a CD-R/CD-RW disc:

- Select "ISO 9660" as the disc format.
- Do not select the "multi-session" recording.
- Finalize the disc.

NOTES

- The unit does not support "packet write" discs.
- If there are any Tracks (files) which are stored on a disc directly and do not belong to any Group (folder), the unit recognized them as belonging to an independent Group.
- The unit does not output a digital audio signal from DIGITAL OUT when playing back an MP3 disc.
- Some disc may not be played back because of the disc characteristics or recording condition.
- The unit plays back Groups/Tracks on an MP3 disc in the alphabetical order.

For example, if there are three Groups titled [one], [two] and [three] on a disc, the playback order is [one], [three] then [two]. Tracks in a Group are played back in the same way.

Unavailable functions

As described earlier, there are some restrictions for playback of MP3 discs. Following functions are not available with MP3 discs.

Unavailable functions for MP3 discs

Function name	Function
Resume	To resume playback
Time search	To locate a desired position in the current track
Manual search	To advance or reverse playback rapidly
A-B repeat	To repeat a desired part
3D phonic	To simulate surround sound

NOTES

- You cannot playback Tracks in the desired (programmed) or random order, nor playback a Track repeatedly.
- The screen saver function is not active with an MP3 disc, as with an Audio CD.

Basic operations

Basic operations using the basic control buttons

MP3

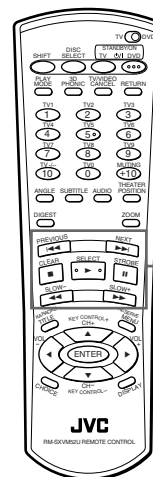

Basic control buttons

The table shows basic functions of basic control buttons (See page 43).

As you can see, ►, ■, || and ◀◀/▶▶ buttons function the same as with Audio CD discs, though ◀◀/▶▶ buttons function differently.

Buttons	Functions
	Starts playback
	Stops playback completely
	Pauses playback temporarily
	Skips back or forward a Track
	Skips back or forward a Group

NOTES

- The current Group and Track numbers are shown on the display window in the following manner.



Current disc number
 Current group number
 Current track number
 Current track elapsed time

- You cannot advance or reverse playback of an MP3 disc rapidly.

Track/Group selection using the numeric buttons

While stopped, you can select a Group to be played using the numeric buttons. During playback, you can select a Track in the current Group to be played using the numeric buttons. Note that you can specify a two-figure Track (up to Track 99) by using the numeric buttons.

How to select a Track or Group:

The same method for selecting a track of an Audio CD disc can be applied for selecting a Group or Track of an MP3 disc.

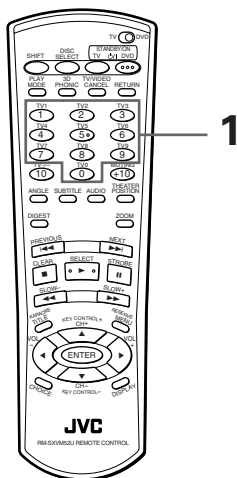

1 Use the numeric buttons to specify the desired Track number directly.

- To select a number between 1 and 10
Press the corresponding button for the number.
- To select a number higher than 10
Use the +10 button.

Examples:
 To select 13 +10 → 3
 To select 34 +10 → +10 → +10 → 4
 To select 40 +10 → +10 → +10 → 10

NOTE

- To select a three-figure Track (Track 100 or higher).
When selecting such a track, “ - - ” is shown, instead of the Track number, in the display window.

Advanced functions

Program playback

MP3

You can playback Groups on an MP3 disc in the desired order.

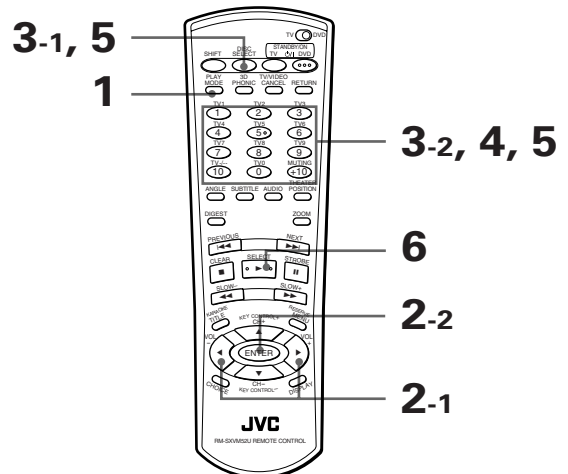

MP3 disc playback

■ While stopped

1 Press PLAY MODE.

The play mode menu appears on the TV screen.

2 Use CURSOR to move to [PROGRAM] and press ENTER.

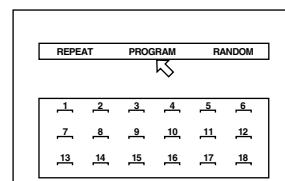

The program table appears under the menu bar (as shown above).

The “PROGRAM” indicator appears in the display window on the front panel.

3 Specify the disc by pressing DISC SELECT followed by the appropriate numeric (1 - 3) button.

4 Specify the group in the desired order using the numeric buttons.

See page 14 for details about how to use the numeric buttons.

5 Repeat steps 3 and 4.

Up to 18 titles or tracks can be programmed. You may select the same title or track more than once.

REPEAT		PROGRAM		RANDOM	
1	2	3	4	5	6
1-1	1-2	2-3	3-7		
7	8	9	10	11	12
13	14	15	16	17	18

The programmed group number is shown under each program number.

• **If you specify a wrong selection**

Press TV/VIDEO CANCEL. The last selection programmed is erased.

• **To clear the program**

Press ■ .

6 Press ► to start program play.

When all of the programmed groups have finished playback, the unit stops but the program remains.

• **To quit program playback**

Press ■ while stopped.

The "PROGRAM" indicator in the display window turns off.

Note that the program remains.

To clear the program, press ■ while the program table is shown on the TV screen.



Hints

- While stopped and the play mode menu is displayed on the TV screen, by moving to [PROGRAM] and pressing ENTER, the program mode quits. Note that the program remains.

NOTES

- You cannot playback Tracks in a Group in the desired order.
- By pressing PLAY MODE during program playback, the program table is displayed on the TV screen and the current program number is indicated in yellow.

Random playback

MP3

You can playback Groups on an MP3 disc in random order.

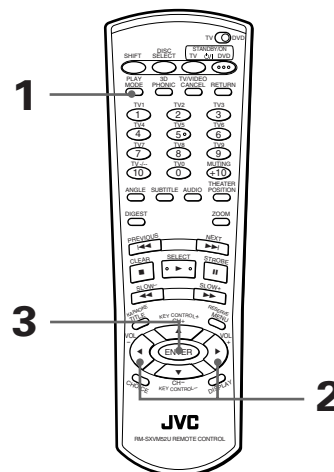

■ While stopped

1 Press PLAY MODE.

The play mode menu appears on the TV screen.

2 Use CURSOR to move to [RANDOM].

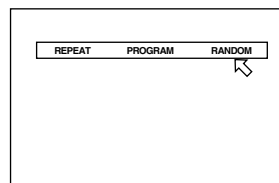

3 Press ENTER.

The unit starts random playback.

The "RANDOM" indicator appears in the display window on the front panel. After playing all groups of the disc, random playback ends.



Hints

- The same group will not be played back more than once during random play.
- **To stop/quit random playback in the middle**
Press ■ to stop playback. The unit is still in random playback mode, so pressing ► starts random playback again.
To quit random playback, press ■ again while stopped. The "RANDOM" indicator in the display window turns off.

NOTES

- Tracks in a Group are played back in the regular order.
- Pressing the button during random playback skips forward or back a track.

Repeat playback

MP3

You can repeat playback of the current Group or all Groups.

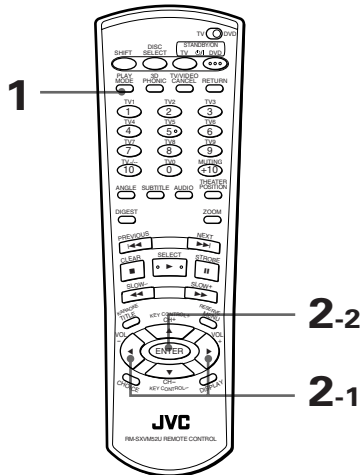

■ During playback or while stopped

1 Press PLAY MODE.

The play mode menu appears on the TV screen.

2 Use CURSOR ◀▶ to move ↷ to [REPEAT], then press ENTER.

Each time you press ENTER, the repeat mode changes as follows depending on the disc type and unit's status:

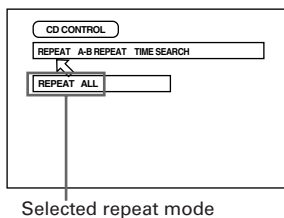

Selected repeat mode

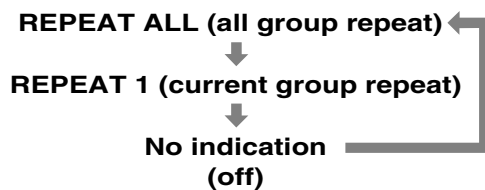

• To stop playback

Press ■.
Repeat playback is stopped, but the current repeat mode is not canceled.

• To quit repeat playback

With ↷ pointed at [REPEAT], press ENTER repeatedly until the mode is set to off.

NOTE

- To turn off the play mode menu display
Press PLAY MODE.

Disc/time information

MP3

English

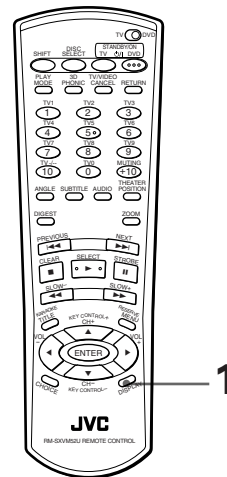

■ During playback

1 Press DISPLAY.

The disc/time display appears on the TV screen.

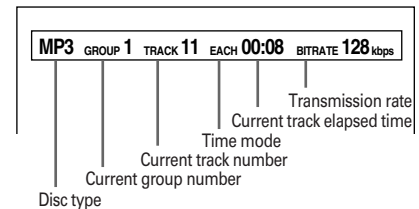

• To turn off the disc/time display

Press DISPLAY.

KARAOKE operation

Preparation

Turning on the KARAOKE function

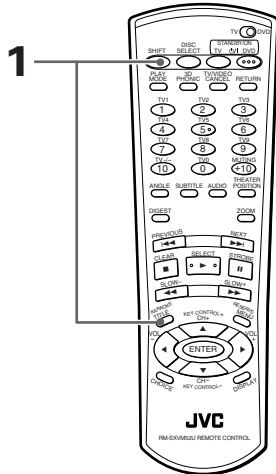

1 Press TITLE-KARAOKE while holding down SHIFT to turn on the KARAOKE function.

Each time you perform the operation above, the KARAOKE function turns on or off. When "on", "KARAOKE" appears in the display on the front panel.

(Display window)



KARAOKE function indicator

Connecting microphones

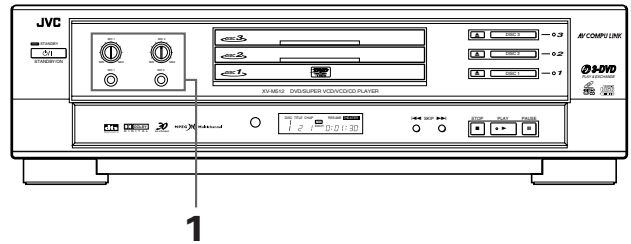

1 Connect microphone(s) to the MIC 1/2 jack(s) on the front panel.

NOTES

- While an Audio CD disc is selected (not only during playback but also while stopped), the input signals from the MIC 1/2 jacks are not output from the DIGITAL OUT jack.
- When a DVD VIDEO disc is selected, you can enjoy the input signals from the MIC 1/2 jacks with the DIGITAL OUT jack (except recorded with linear PCM audio). In such case, set the "DIGITAL AUDIO OUTPUT" setting in the "AUDIO" page of the preference display to "PCM ONLY" (see page 54).
- To adjust the microphone volume, use MIC 1/2 LEVEL. Turning it clockwise raises the level, while turning it counter-clockwise lowers the levels.

NOTES

- When playing back a MP3 disc or a DVD VIDEO recorded with linear PCM audio, you cannot turn on the KARAOKE function.
- When the KARAOKE function is active, you can specify a title in a DVD VIDEO disc using the numeric buttons even during playback. Because most DVD VIDEO discs assign a title to each song, you can easily select the desired song using the numeric buttons.
(When the KARAOKE function is inactive, using the numeric button selects a DVD VIDEO chapter during playback.)
- During program or random playback, you cannot turn on the KARAOKE function.

Reserving songs

You can reserve up to 12 songs to play in the desired order.

Of course, it is possible to enjoy KARAOKE without reserving songs.

To playback songs reserved

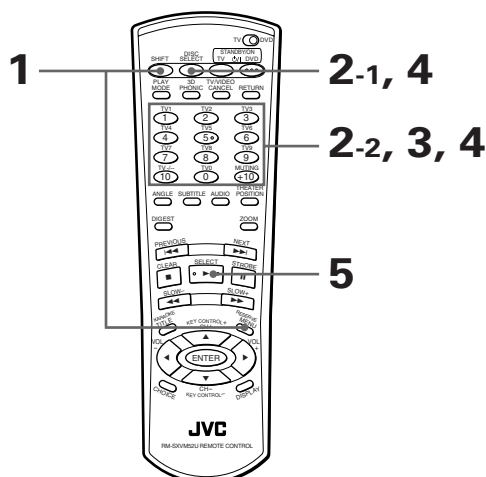

■ When the KARAOKE function is active

1 Press MENU-RESERVE while holding down SHIFT.

The reservation table appears on the TV screen. If any song(s) is/are reserved, The "PROGRAM" indicator appears in the display window on the front panel.

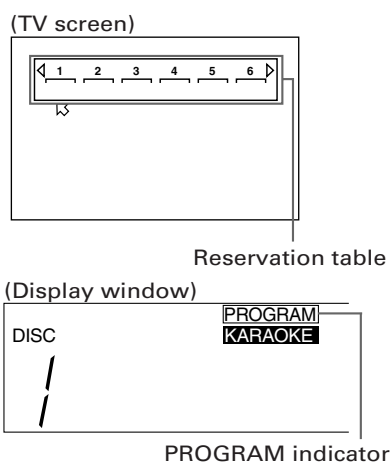

2 Specify the disc by pressing DISC SELECT followed by the appropriate numeric (1 - 3) button.

3 Specify the titles or tracks in the desired order using the numeric buttons.

See page 14 for details about how to use the numeric buttons.

4 Repeat steps 2 and 3.

Up to 12 titles or tracks can be programmed. You may select the same title or track more than once.

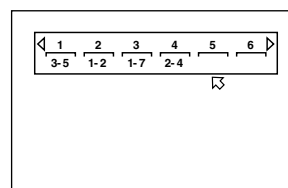

• Example:

To reserve track 13 of the disc loaded in tray 2:
Press DISC SELECT → 2 → +10 → 3.

The specified song is reserved and the moves ↔ to the next position.

You can reserve the same song more than once.

5 Press ▶.

The unit starts playback of the first reserved song.



- If you operate steps 1 through 4 during playback and press ▶, the unit stops the current playback and starts playback of the songs in the reserved order.
- If you do not press ▶ after carrying out step 1 through 4, the unit continues normal playback. To begin playback of reserved songs, bring up the reservation table on the TV screen and press ▶.

A song which has finished playback is deleted from the reservation table.

After playing back all reserved songs, the unit stops, and the "PROGRAM" indicator in the display window turns off.

• To check the reserved songs

Press MENU - RESERVE while holding down SHIFT to display the reservation table.

• To cancel display of the reservation table

Press MENU - RESERVE while holding down SHIFT.

• To reserve additional songs

Make sure that points the next to the last song in the reservation table on the TV screen, and use the DISC SELECT and numeric buttons to select the song(s) you want to reserve.

• To insert a song to be reserved

Move ↔ to the position where you want to insert a song using CURSOR ◀/▶, then press the DISC SELECT and numeric button to select the song you want to reserve.

• To cancel a reserved song

Move ↔ to the song you want to cancel using CURSOR ◀/▶, then press TV/VIDEO - CANCEL while holding down SHIFT.

• To cancel all songs

While the unit is stopped, press ■.

NOTES

- You cannot reserve songs during Video CD/SVCD playback with PBC. To reserve songs, press **■** before operating the above.
- For Audio CDs, the A-B repeat function cannot be operated while playing back a reserved song.

Selecting audio

Most KARAOKE discs have the capability of adding a "Guide vocal" or "Guide melody" to the KARAOKE accompaniment.

Selecting audio track(s) [AUDIO]



With most DVD VIDEO or SVCD KARAOKE discs, you can choose audio track(s) some options such as "with guide vocal," "with guide melody" and "accompaniment only." You can choose "AUDIO" only for DVD VIDEO and SVCD discs.

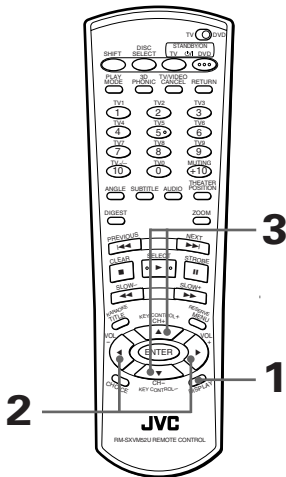

■ During playback, when the KARAOKE function is active

1 Press DISPLAY.

The KARAOKE menu appears on the TV screen.

2 Use CURSOR **◀▶** to move **⏏** to [AUDIO].

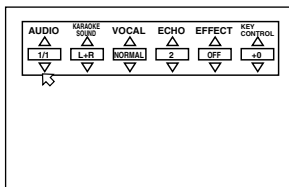

3 Use CURSOR **▲▼** to select the desired audio track(s) to be played back.

• **Example:**

(For DVD VIDEO)

- 1/3 Multi audio KARAOKE
- 2/3 With guide vocal
- 3/3 Accompaniment only

AUDIO

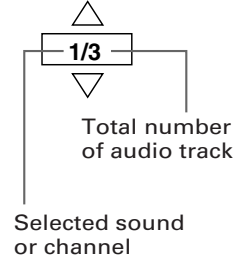

(For SVCD)

- 1/2 With guide vocal
- 2/2 Accompaniment only

AUDIO

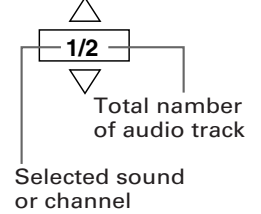

NOTES

- To turn off the KARAOKE menu
Press DISPLAY.
- When **⊘** appears on the TV screen
The disc does not contain multi audio tracks, or the disc prohibits the audio selection.

Selecting KARAOKE sound [KARAOKE SOUND]



Among "KARAOKE" DVD VIDEO discs, there are "Multi-sound KARAOKE" discs. With such a disc, for example, you can sing along with the other vocal part recorded in a disc.

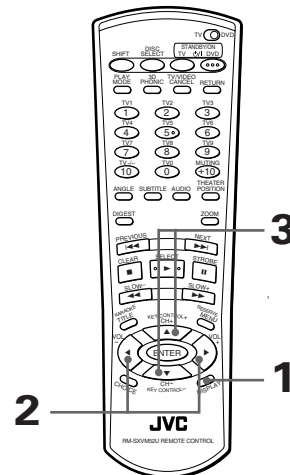

■ During playback, when the KARAOKE function is active

1 Press DISPLAY.

The KARAOKE menu appears on the TV screen. When playing back a "Multi-sound KARAOKE" disc, [AUDIO] should be set to 1 (See the left column).

2 Use CURSOR ◀/▶ to move ⏏ to [KARAOKE SOUND].

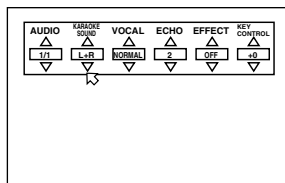

3 Use CURSOR ▲/▼ to select the desired sound to be played back.

• **Example 1: A multi-sound KARAOKE DVD VIDEO**

Pressing CURSOR ▲ button cycles the sound as follows. Pressing CURSOR ▼ cycles the sound in reverse order.

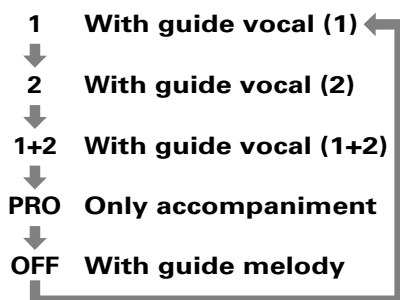

"2" and "1+2" above appear only with materials for vocal duet.

• **Example 2: A Video CD, SVCD or Audio CD with KARAOKE**

Pressing CURSOR ▲ cycles the sound as follows. Pressing CURSOR ▼ cycles the sound in reverse order.

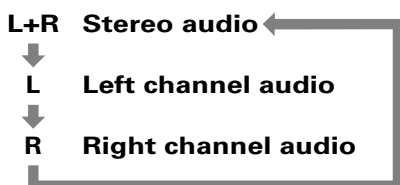

NOTES

- To turn off the KARAOKE menu Press DISPLAY.
- For Video CD and SVCD, the selection of [KARAOKE SOUND] matches the audio selection using the AUDIO button.
- With a DVD VIDEO disc which does not contain "Multi-sound KARAOKE," [KARAOKE SOUND] cannot be changed.

Masking the vocal recorded on a disc [VOCAL MASK]



English

Using the Vocal mask function, you can mask a vocal recorded on normal non-KARAOKE discs. When playing back a KARAOKE disc, such as a disc with multiplex audio and multi-sound KARAOKE, eliminate the vocal by selecting "KARAOKE SOUND," instead of "VOCAL MASK" (See page 48).

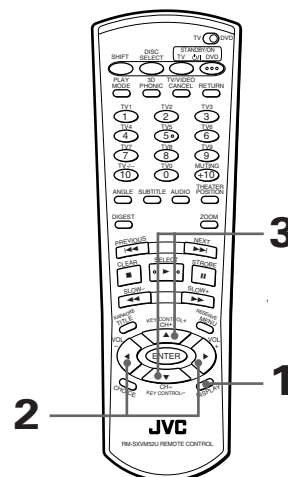

■ During playback, when the KARAOKE function is active

1 Press DISPLAY.

The KARAOKE menu appears on the TV screen. If [KARAOKE SOUND] is set to L or R, the Vocal mask function does not work correctly. Change the setting to L+R (See page 48).

2 Use CURSOR ◀/▶ to move to [VOCAL].

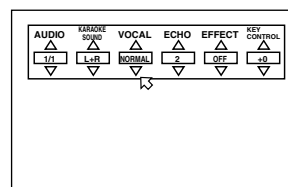

3 Use CURSOR ▲/▼ to select [MASK].

Pressing CURSOR ▲ cycles the vocal mode as follows. Pressing CURSOR ▼ cycles the mode in reverse order.

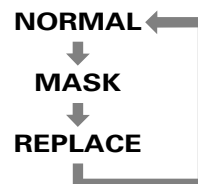

KARAOKE operation

NOTES

- To turn off the KARAOKE menu
Press DISPLAY.
- If [KARAOKE SOUND] is set to L or R, the vocal mask function does not work correctly.
- With some materials, such as those recorded in monaural and sung by multiple voices, the voice may not be satisfactorily masked.

Playing back the guide vocal only when you stop singing [VOCAL REPLACE]



You may have experiences where you could not sing in the middle of a KARAOKE song because you forgot the melody, etc. In such cases, by using the vocal replace function, the guide vocal automatically replaces your voice when you stop singing. It may be useful for practicing KARAOKE.

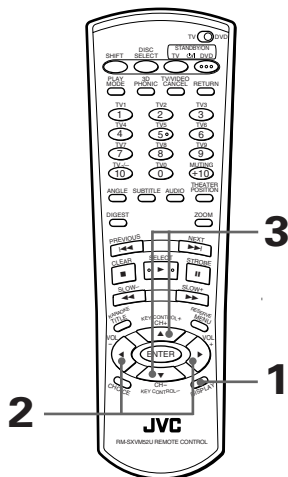

■ During playback, when the KARAOKE function is active

1 Press DISPLAY.

The KARAOKE menu appears on the TV screen. If the disc is recorded with the multiplex audio, set [KARAOKE SOUND] to L or R for playing back the guide vocal.

If the disc is not recorded for KARAOKE, set [KARAOKE SOUND] to L+R (See page 48 and 49).

2 Use CURSOR ◀/▶ to move ↻ to [VOCAL].

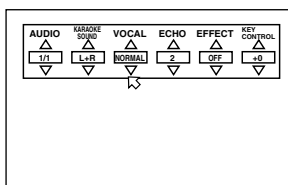

3 Use CURSOR ▲/▼ to select [REPLACE].

Pressing CURSOR ▲ cycles the mode as follows. Pressing CURSOR ▼ cycles the mode in reverse order.

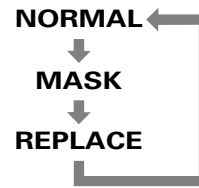

Hints

- The recorded voice (guide vocal) is played back only when no sound is fed to the microphone(s).

NOTES

- To turn off the KARAOKE menu
Press DISPLAY.
- When playing back a disc with the multiplex audio or with multi-sound KARAOKE, the guide vocal is not played back at all. With other discs, the voice may not be satisfactorily masked.

Adding an effect to your voice

You can add various effects to your voice using the Echo and Vocal Effect functions.

Adding an echo effect [ECHO]

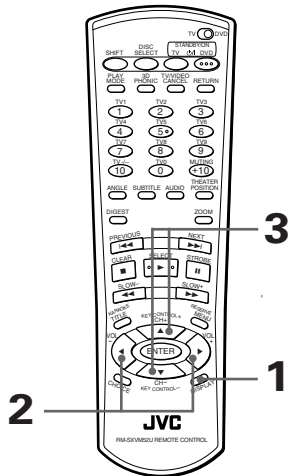

■ When the KARAOKE function is active

- 1 Press DISPLAY.
The KARAOKE menu appears on the TV screen.
- 2 Use CURSOR ◀/▶ to move to [ECHO].

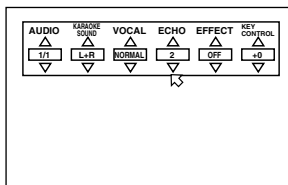

- 3 Use CURSOR ▲/▼ to adjust the echo level.
Each time you press CURSOR ▲, the echo level increases.
Pressing CURSOR ▼ changes the echo level decreases.
The higher the number, the stronger the echo.

OFF ↔ 1 ↔ 2 ↔ 3

NOTE

- To turn off the KARAOKE menu
Press DISPLAY.

Adding various effects to the vocal [VOCAL EFFECT]

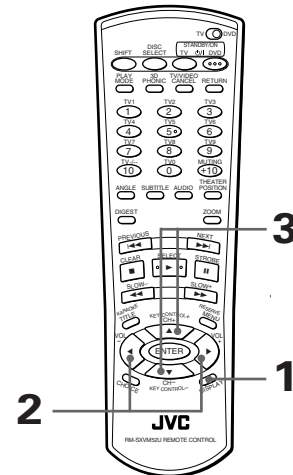

■ When the KARAOKE function is active

- 1 Press DISPLAY.
The KARAOKE menu appears on the TV screen.
- 2 Use CURSOR ◀/▶ to move to [EFFECT].

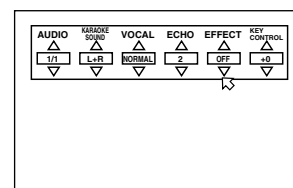

- 3 Use CURSOR ▲/▼ to select the effect.
Pressing CURSOR ▲ cycles the effect as follows.
Pressing CURSOR ▼ cycles the effect in reverse order.

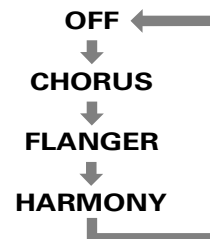

- **CHORUS:**
Produces a doubling effect on your vocal, as if another person is singing in unison.
- **FLANGER:**
Adds a wet, metallic sweeping sound to your voice, similar to some electric guitar sounds.
- **HARMONY:**
Adds a harmony vocal to your voice.

NOTE

- To turn off the KARAOKE menu
Press DISPLAY.

Shifting the musical key

You can shift the musical key of a song recorded on a disc to fit to your voice.

To shift the musical key



From normal screen

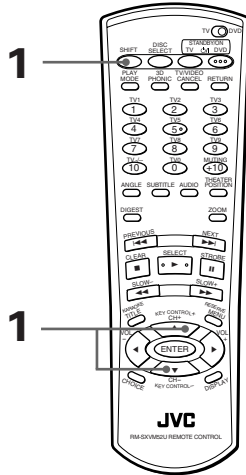

■ When the KARAOKE function is active

1 Use the CURSOR ▲/▼ (KEY CONTROL +/-) while holding down SHIFT.

Pressing ▲ raises the key.

Pressing ▼ drops the key.

The key shift status appears in the display window on the front panel, as well as on the TV screen.

(Display window)

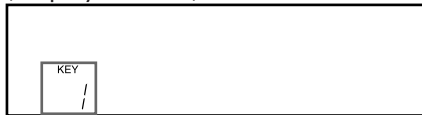

Selected key number

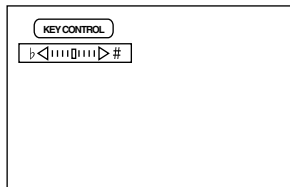

NOTES

- The key returns to the normal key after the current song ends.
- While an Audio CD disc is selected (not only during playback but also while stopped), the key control function does not affect the output signal from the DIGITAL OUT jack.

From on-screen display

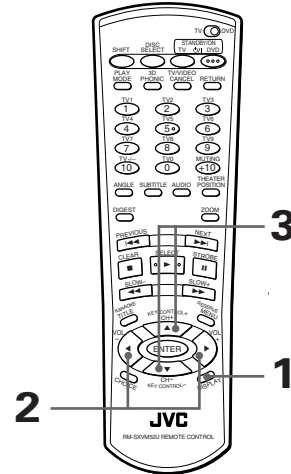

■ When the KARAOKE function is active

1 Press DISPLAY.

The KARAOKE menu appears on the TV screen.

2 Use CURSOR ◀/▶ to move to [KEY CONTROL].

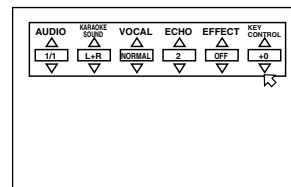

3 Use CURSOR ▲/▼ to shift the musical key.

Pressing CURSOR ▲ raises the key.

Pressing CURSOR ▼ drops the key.

The key shift status (see the left column) appears on the TV screen.

NOTES

- To turn off the KARAOKE menu
Press DISPLAY.
- The key returns to the normal key after the current song ends.
- While an Audio CD disc is selected (not only during playback but also while stopped), the key control function does not affect the output signal from the DIGITAL OUT jack.

Selecting preferences

You can set various preferences for playback via four dedicated displays.

How to set preferences

Note that you cannot bring up a preference display during playback or when an Audio CD is loaded in the tray.

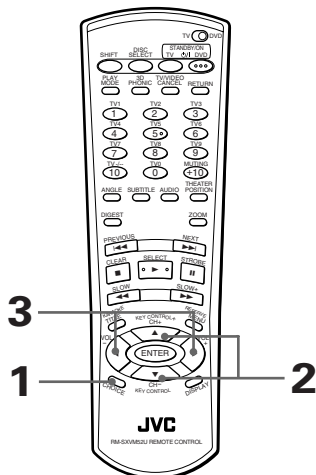

- When no disc is inserted in the tray, or when a DVD VIDEO, Video CD or SVCD is inserted and stopped

1 Press CHOICE.

One of the preference pages appears on the TV screen. There are four preference pages: LANGUAGE, AUDIO, DISPLAY and SYSTEM. To turn the page, move \leftarrow to the desired tab using CURSOR \leftarrow/\rightarrow .

LANGUAGE

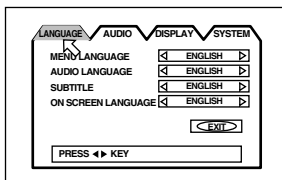

AUDIO

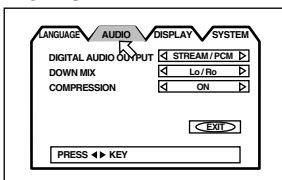

DISPLAY

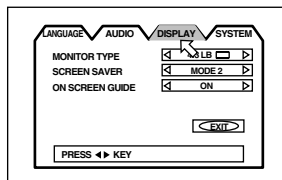

SYSTEM

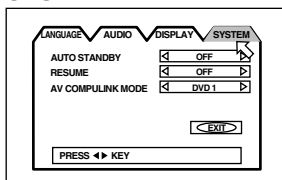

2 Move \leftarrow to select the item you want to set by using CURSOR $\blacktriangle/\blacktriangledown$.

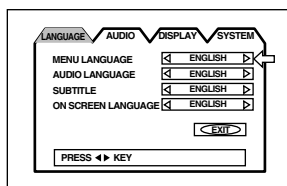

3 Press CURSOR \leftarrow/\rightarrow to select the setting you want.

- To turn off the preference display, press CHOICE or move \leftarrow to [EXIT] and press ENTER.
- For details about each setting, see the following paragraphs:

LANGUAGE page

MENU LANGUAGE

You can select the default "display" language to be displayed if it is contained on the disc.

Each time you press CURSOR \blacktriangleright , the language setting changes in the following order:

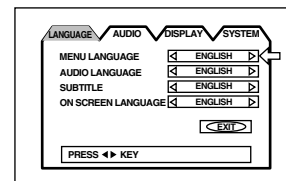

ENGLISH → SPANISH → FRENCH → CHINESE → GERMAN → ITALIAN → JAPANESE → language code from AA to ZU

(See "Appendix A: Table of languages and their abbreviations" at the end of this manual.)

Pressing CURSOR \blacktriangleleft changes the language setting in the reverse order of the above.

- * If the selected language is not recorded, the disc's default display language will be displayed.

AUDIO LANGUAGE

You can select the default audio language to be played if it is contained on the disc.

Each time you press CURSOR \blacktriangleright , the language setting changes in the following order :

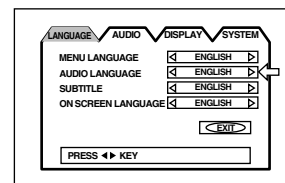

ENGLISH → SPANISH → FRENCH → CHINESE → GERMAN → ITALIAN → JAPANESE → language code from AA to ZU

(See "Appendix A: Table of languages and their abbreviations" at the end of this manual.)

Pressing CURSOR \blacktriangleleft changes the language setting in the reverse order of the above.

- * If the selected language is not recorded, the disc's default audio language will be played.

SUBTITLE

You can select the default subtitle language to be displayed if it is contained on the disc.

Each time you press CURSOR ►, the language setting changes in the following order:

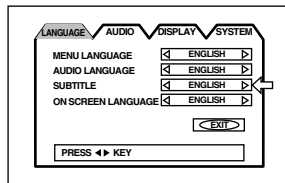

ENGLISH → SPANISH → FRENCH → CHINESE → GERMAN → ITALIAN → JAPANESE → language code from AA to ZU

(See "Appendix A: Table of languages and their abbreviations" at the end of this manual.)

Pressing CURSOR ◀ changes the language setting in the reverse order of the above.

* If the selected language is not recorded, the disc's default subtitle language will be displayed.

ON SCREEN LANGUAGE

You can select the on-screen display language to be displayed.

Each time you press CURSOR ►, the language setting changes as follows:

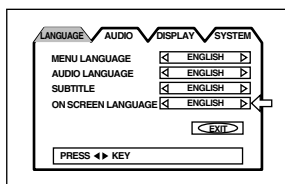

English	ON SCREEN LANGUAGE ◀ ENGLISH ▶
Chinese	说明字幕 ◀ 中国语 ▶
Spanish	IDIOMA EN PANTALLA ◀ ESPAÑOL ▶

Pressing CURSOR ◀ changes the language setting in the reverse order of the above.

AUDIO page

DIGITAL AUDIO OUTPUT

To connect the unit's digital output to an external device equipped with a digital input, this item must be set correctly.

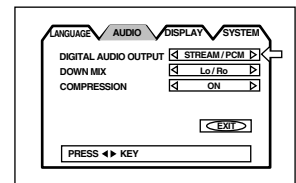

- PCM ONLY**

When you connect the DIGITAL OUT jack of the unit to the linear PCM digital input of other audio equipment.

- STREAM/PCM**

When you connect to the digital input of an amplifier with a built-in DTS, Dolby Digital, or MPEG multichannel decoder.

- DOLBY DIGITAL/PCM**

When you connect to the digital input of a Dolby Digital decoder, or an amplifier with a built-in Dolby Digital decoder.

The following chart shows the relationship between types of playback discs and output signals.

Playback discs	Output		
	STREAM/PCM	DOLBY DIGITAL/PCM	PCM ONLY
DVD with 48 kHz, 16 bit linear PCM	48 kHz, 16 bit linear PCM	←	←
DVD with 48 kHz, 20/24 bit linear PCM	48 kHz, 20/24 bit linear PCM	←	←
DVD with 96 kHz, linear PCM	No output	←	←
DVD with DTS	DTS bitstream	No output	←
DVD with Dolby Digital	Dolby Digital bitstream	←	48 kHz, 16 bit linear PCM
DVD with MPEG multichannel	MPEG bitstream	48 kHz, 16 bit linear PCM	←
Video CD/SVCD	44.1 kHz, 16 bit linear PCM	←	←
Audio CD	44.1 kHz, 16 bit linear PCM	←	←
Audio CD with DTS	DTS bitstream	←	←
CD-R/RW with MP3	No output	←	←

NOTES

- The unit does not provide the DTS decoding function.
- When playing a DVD VIDEO or Audio CD disc with DTS, use a DTS decoder to get correct signals from your speakers. Never use the unit's analog output jacks, which output incorrect signals that may damage your speakers.
- If you connect the analog outputs and digital outputs simultaneously, be sure to select the source of the amplifier correctly, or set the level control of the amplifier connected to the analog outputs to minimum.
- While an Audio CD disc is selected (not only during playback but also while stopped), the input signals from the MIC 1/2 jacks are not output from the DIGITAL OUT jack.
- When the KARAOKE function is active and the DVD VIDEO disc is selected, you can enjoy the input signals from the MIC 1/2 jacks with the DIGITAL OUT jack (except recorded with linear PCM audio). In such case, set the "DIGITAL AUDIO OUTPUT" to "PCM ONLY".

DOWN MIX

To playback a DVD VIDEO disc recorded with surround multichannel audio correctly, the DOWN MIX setting must be properly made according to your audio system. Note that this setting affects the analog audio output signal from the AUDIO OUT jacks when playing back a DVD VIDEO disc recorded with surround multichannel audio.

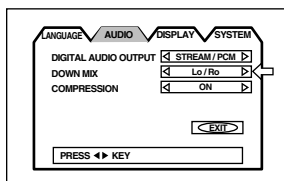
• **Lt/Rt**

When you enjoy surround audio by connecting the unit's AUDIO output to a surround decoder or an internal amplifier.

• **Lo/Ro**

When you enjoy conventional 2-channel stereo audio by connecting the unit's AUDIO output to a stereo amplifier/receiver or television set, or when you duplicate audio of a DVD VIDEO disc recorded with surround audio to your MD, cassette, etc.

NOTES

- The Down mix function does not work when the 3D PHONIC function is activated.
- The DOWN MIX setting does not affect an MPEG or Dolby Digital bitstream signal from DIGITAL OUT.
To enjoy the DOWN MIX effect from DIGITAL OUT when playing back a disc recorded with the MPEG multichannel or Dolby Digital format, set "DIGITAL AUDIO OUTPUT" to "PCM ONLY" (see page 54).
- When playing back a disc recorded with DTS, you cannot get the DOWN MIX effect from both DIGITAL and ANALOG outputs.

COMPRESSION

You can compress the dynamic range of the sound if needed. Using this function, you can listen to sound at low volumes easily.

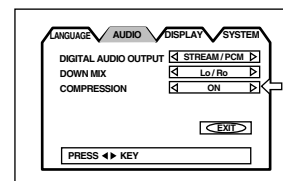
• **ON**

Audio is played back with the dynamic range compressed.

• **OFF**

Audio is played back as it was recorded.

NOTES

- The Compression function works only when playing back a disc recorded with DOLBY DIGITAL 1CH or 2CH. The setting is not effective for other discs.
- The Compression function does not work when the 3D PHONIC function is activated.

DISPLAY page**MONITOR TYPE**

You can select the monitor type to match your TV when you playback DVD VIDEO discs recorded for wide screen televisions.

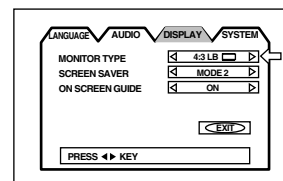
• **4:3 LB** (Letter Box Conversion)

Should be selected when you connect a normal TV to the unit.

When you play a wide picture recorded on a DVD VIDEO disc, the picture is displayed with bands across the upper and lower portions of the screen.

• **4:3 PS** (Pan Scan Conversion)

Should be selected when you connect a normal TV to the unit. When you play a wide picture recorded on a DVD VIDEO disc, a portion of the picture is automatically cut off from the left and right sides of the image.

Depending on the disc, it may not be possible to playback in this mode. In that case, the picture is played back as in 4:3 LB mode.

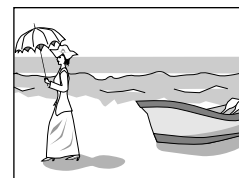

16:9 WIDE (Wide Television screen)

Should be selected when you connect a wide-screen TV to the unit.

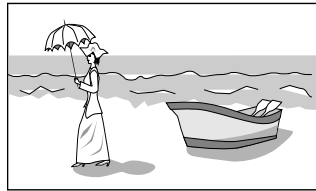

SCREEN SAVER

A television monitor screen may be burned out if a static picture is displayed for a long time. To prevent this, the unit automatically activates the screen saver function if a static picture, such as an on-screen display or menu, is displayed for over 5 minutes.

MODE 1

The current picture gets dark.

MODE 2

The “screen saver” picture appears and its brightness changes.

OFF

The screen saver function is off.

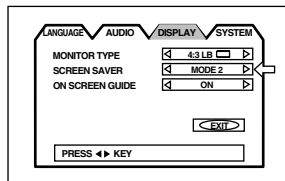

NOTES

- The monitor screen of a projector or projection TV is easily burned out if the screen saver mode is set to OFF and a static picture is displayed for a long time.
- The screen saver function is not activated when the selected disc is an Audio CD.

ON SCREEN GUIDE

The unit can display “on-screen guide” icons or characters on the picture, which show what is happening to the disc or the unit.

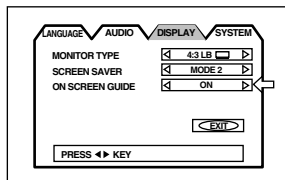

ON

The on-screen guide will be displayed.

OFF

The on-screen guide will not be displayed.

Examples of “on-screen guide” icons or characters:



SYSTEM page

AUTO STANDBY

When the unit is stopped for more than 30 minutes or 60 minutes, the unit enters standby mode automatically.

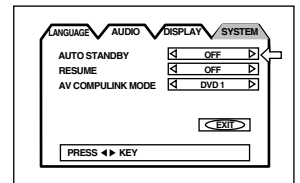

60

Time is set to 60 minutes.

30

Time is set to 30 minutes.

OFF

The auto standby function is off.

RESUME

You can select the resume function to be on or off. See page 26.

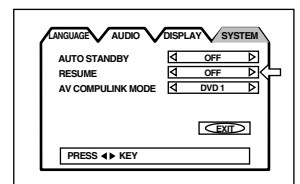

ON

Pressing ► while stopped or on standby starts playback from the resume point if it is memorized.

OFF

Pressing ► while stopped or on standby starts playback from the beginning of the disc.

AV COMPULINK MODE

If you use the AV COMPULINK system, you must set this item correctly.

Select from the three options: “DVD1,” “DVD2” and “DVD3” according to the equipment to be connected. See page 60.

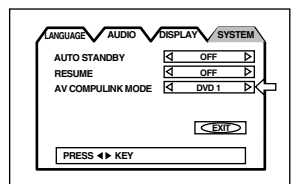

Limiting playback by children

This function restricts playback of DVD VIDEO discs which contain violent (and other) scenes according to the level set by the user. For example, if a movie which includes violent scenes supports the parental lock feature, such scenes which you do not want to let children view can be cut or replaced with other scenes.

To set Parental Lock for the first time [PARENTAL LOCK]

DVD VIDEO

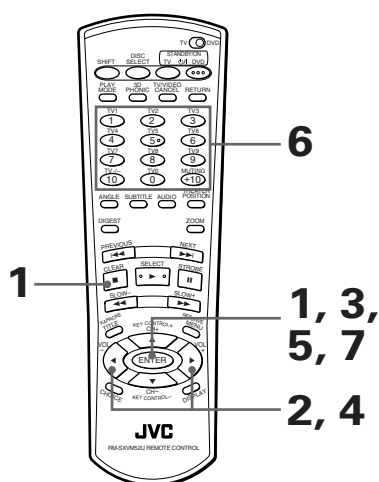

- While a DVD VIDEO disc is stopped or no disc is inserted

1 Press ENTER while holding down ■ on the remote control unit.

The Parental Lock on-screen display appears on the TV screen.

↵ points [Country Code].

2 While ↵ points [Country Code], use CURSOR ◀▶ to select the country code.

The country code whose standards were applied to rate the DVD VIDEO disc should be selected.

See "Appendix B: Country code list for parental lock".

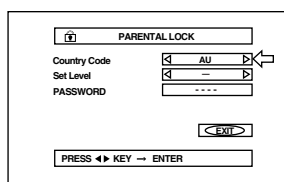

3 Press ENTER.

↵ moves to [Set Level].

4 While ↵ points [Set Level], use CURSOR ◀▶ to select the parental lock level.

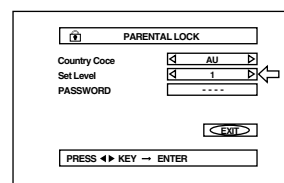

Each time you press CURSOR ◀▶, the parental level changes as follows:

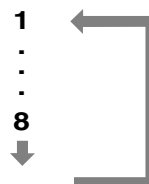

- "1" is the strictest level. "-" means no restriction. Discs rated higher than the selected level are restricted.

5 Press ENTER.

↵ moves to [PASSWORD].

6 Enter your 4-digit password using the numeric buttons (0 to 9).

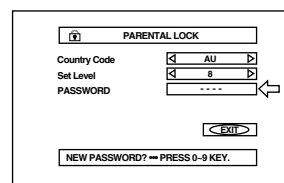

7 Press ENTER.

The parental level and password are set.

↵ moves to [EXIT].

Pressing ENTER again returns to the opening display.



- If you enter an undesired password in step 6 above, reenter the password before pressing ENTER.

To change the settings [PARENTAL LOCK]



You can change the Parental lock settings later.

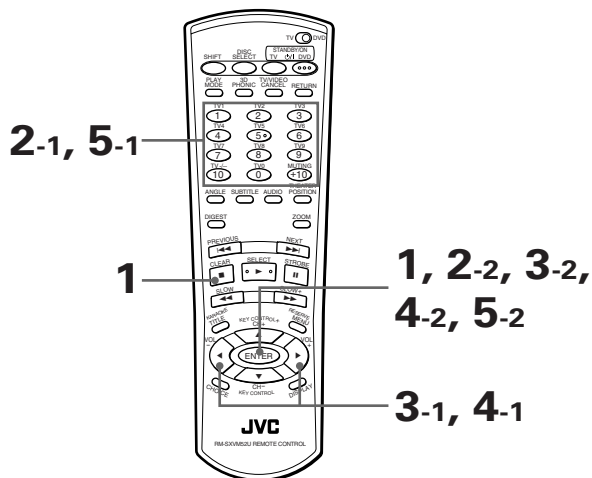

■ While a DVD VIDEO disc is stopped or no disc is inserted

1 Press ENTER while holding down ■ on the remote control unit.

The Parental Lock on-screen display appears on the TV screen.

↵ points [PASSWORD].

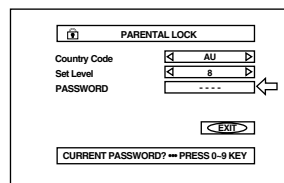

2 Enter your current 4-digit password using the numeric buttons (0 to 9) and press ENTER.

↵ moves to [Country Code] if you enter the correct password.

If you enter the wrong password, "WRONG! RETRY..." appears on the TV screen, and you cannot go to next step.

3 To change the country code, use CURSOR ◀/▶ to select the desired country code and press ENTER.

↵ moves to [Set Level].

When you change the country code, you must select the parental level.

4 To change the set level, use CURSOR ◀/▶ to select the desired level while ↵ points [Set Level], and then press ENTER.

↵ moves to [PASSWORD].

5 Enter the password using the numeric buttons (0 to 9) and press ENTER.

↵ moves to [EXIT].

The password entered in the above step becomes the new password. If you do not change the password, enter the same password as in the step 2. Even if you want to change only the country code and/or parental level, do not forget to enter the password after changing the country code and/or parental level. Otherwise, the new country code and/or parental level will not become effective. Pressing ENTER again returns to the opening display.

NOTES

- When you enter the wrong password more than 3 times in step 2 above, ↵ moves to [EXIT] automatically and CURSOR ▲/▼ does not work.

- If you forget your password in step 2

Enter "8888."

To temporarily release the Parental lock [PARENTAL LOCK]



When you set the parental level strictly, some discs may not be played back at all. When you insert such a disc and try to play it, the following Parental Lock on-screen display appears on the TV screen, asking you whether you want the parental lock to be temporarily released or not.

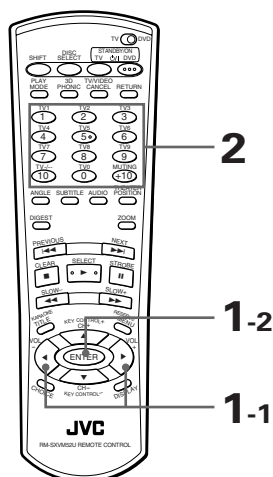

- 1** Use the CURSOR $\blacktriangle/\blacktriangledown$ to move \leftarrow to [YES], then press ENTER.

\leftarrow moves to the PASSWORD field. When selecting [NO], press \blacktriangle (Open/Close) to remove the disc.

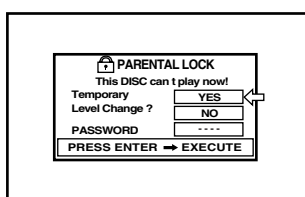

- 2** Enter your 4-digit password using the numeric buttons (0 to 9).

If you enter the wrong password, "WRONG! RETRY..." appears on the TV screen.

Enter the correct password.

The Parental lock is released, and the unit starts playback.

NOTE

- When you enter the wrong password more than 3 times in step 2 above, \leftarrow moves to [NO] automatically and CURSOR $\blacktriangle/\blacktriangledown$ do not work.

AV COMPU LINK remote control system

The JVC AV COMPU LINK system allows you to enjoy video or audio with the simplest operation.

If your video/audio player (such as a DVD player, CD player and VCR) and television or/and amplifier/receiver support the JVC AV COMPU LINK system and are tied with the JVC AV COMPU LINK cable(s), when you simply starting the player, all the necessary settings of the television and/or amplifier/receiver for enjoying playback are automatically performed.

AV COMPU LINK

Connection and setup

Using the AV COMPU LINK cable, connect the AV COMPU LINK terminals of each component to one another.

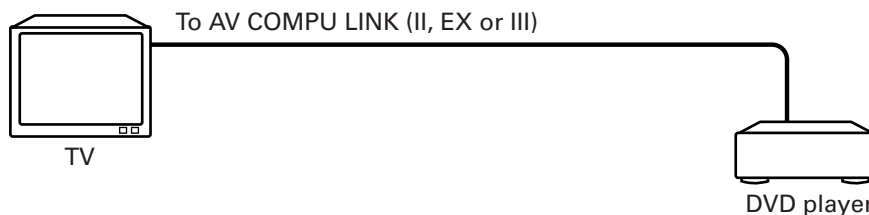

- If you connect the unit to a television via AV COMPU LINK, set the unit's AV COMPU LINK setting as follows.
 - When connecting to VIDEO-1 input terminal of the television: DVD2
 - When connecting to VIDEO-2 input terminal of the television: DVD3

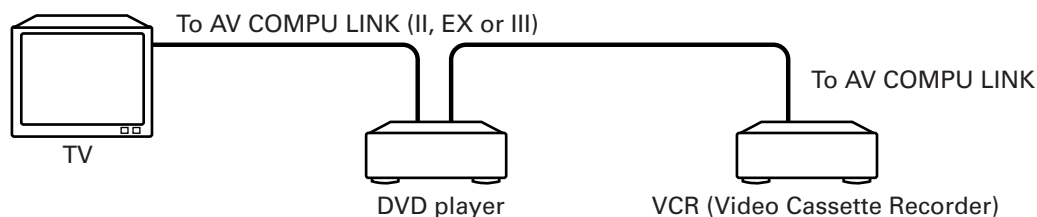

- If you connect a DVD player to a television and VCR via AV COMPU LINK, set the VCR's Remote Control Code and the unit's AV COMPU LINK setting as follows.
 - When connecting to VIDEO-1 input terminal of the television:
The unit's AV COMPU LINK setting: DVD2
VCR's Remote Control Code: B
 - When connecting to VIDEO-2 input terminal of the television:
The unit's AV COMPU LINK setting: DVD3
VCR's Remote Control Code: A

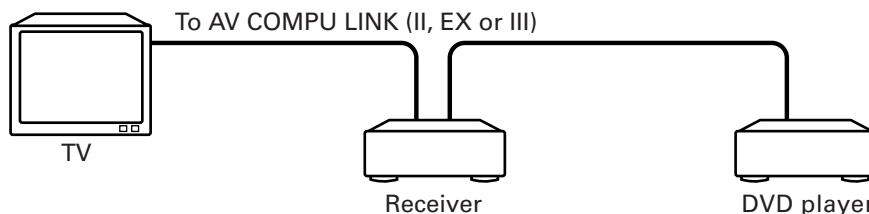

- If you connect the unit to a television and receiver via AV COMPU LINK, set the unit's AV COMPU LINK setting to DVD1.
 - The unit's AV COMPU LINK setting is operated in the SYSTEM page of the preference display. See page 56 for operation.
 - For information on the connection between the TV and the Receiver, refer to the Receiver's Instructions.

IMPORTANT!

- When you make video connection between the unit and another device (such as a receiver and TV) via the composite, S-video or component jacks, as well as AV COMPU LINK connection, see also the instruction manual of the other device.

Notes for connection

- If you connect the unit to a receiver via AV COMPU LINK in a system including a Dolby Digital decoder, some functions may not be performed automatically.
- Connect the AUDIO OUT jacks of the unit to the audio input jacks of a receiver that indicating "DVD." Otherwise, the system will not work correctly.
- There may be no description about connections to the unit in the instruction manual of a television or VCR. However a television or VCR with AV COMPU LINK terminals indicating "II," "EX" or "III" can be connected to the unit.

Operation

You can enjoy pictures and/or sound by just putting a source component (which plays back the pictures and/or sound such as a DVD player or VCR) into play mode. You do not have to operate the TV and receiver including not having to perform power switching.

- 1** Turn on the main power of the television.
- 2** Insert a disc (or tape) into the source component.
- 3** Press ► of the source component.

The following actions are performed automatically:

- Turning on the power for the television.
- Setting the source of the television to the external input (VIDEO-1 or VIDEO-2).
- Turning on the power for the receiver.
- Setting the source of the receiver to the component which has started playback.

Care and handling of discs

How to handle discs

When handling a disc, do not touch the surface of the disc. Since discs are made of plastic, they are easily damaged. If a disc gets dirty, dusty, scratched or warped, the images and sound will not be picked up correctly, and such a disc may cause the player to malfunction.

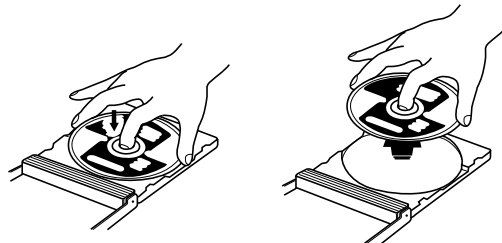

Label side

Do not damage the label side, stick paper to or use any adhesive on its surface.

Storage

Make sure that discs are kept in their cases. If discs are piled on top of one another without their protective cases, they can be damaged. Do not put discs in a location where they may be exposed to direct sunlight, or in a place where the humidity or temperature is high. Avoid leaving discs in your car!

Maintenance of discs

If there are fingerprints or other dirt adhering to a disc, wipe with a soft dry cloth, moving from the center outwards.

If a disc is difficult to clean, wipe with a cloth moistened with water. Never use record cleaners, petrol, alcohol or any anti-static agents.

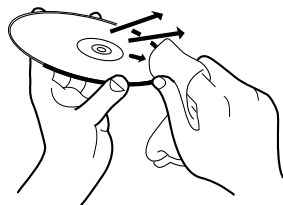

CAUTION

Sometimes during play noise or images may be garbled. This is sometimes due to the disc. (It may not be up to industry standards.)

These symptoms are caused by the discs, not by the malfunction of the unit.

Troubleshooting

What appears to be a malfunction may not always be serious. Please go through the following list before requesting service.

Symptom	Possible case	Remedy
Power does not come on.	Power plug is not inserted securely.	Plug in securely.
Remote control does not work.	Too far from the unit.	Move closer to the unit.
	The tip of the remote unit is not pointed in the right direction.	Point the infrared light-emitting window toward the remote sensor on the front panel.
	Batteries are exhausted.	Replace the batteries with new ones.
	Battery polarity is incorrect.	Take out the batteries and insert them again in the correct direction.
No picture is displayed on the monitor.	Connection of video cable is incorrect.	Connect the cable correctly.
	Input selection of TV is incorrect.	Select correctly.
	Disc is not playable.	Use a playable disc. (See page 15.)
No picture is displayed on the monitor when using the COMPONENT or S-VIDEO output jack(s).	Jack(s) at use is (are) not active.	Make them active. (See page 17.)
Picture is noisy.	The unit is connected to a VCR directly and the copyguard function is activated.	Connect the unit so that the picture signal flows directly to the TV.
No audio is reproduced.	Connection is incorrect.	Check the connections.
	Input selection of amplifier is incorrect.	Select correctly.
No audio is reproduced when playing back a DVD disc recorded with 96 kHz, linear PCM audio.	The audio signal is not derived from the unit's DIGITAL OUT.	Use the AUDIO OUT when playing back such discs.
Sound is distorted or noise is generated.	Disc is dirty.	Wipe the disc surface.
Picture does not fit the television screen.	MONITOR TYPE is not correctly set.	Select monitor type correctly. (See page 55.)
	Television is not correctly set.	Set the television correctly.
Operation is not possible.	Microcomputer malfunction due to lightning or static electricity.	Turn off the power and unplug the power cord, then connect the power cord again.
	Moisture condensation caused by a sudden change of temperature or humidity.	Turn off the power, then turn it on a few hours later.

Specifications

General

Readable discs: DVD VIDEO, Audio CD, Video CD, SVCD
 Video format: NTSC/PAL selectable

Other

Power requirements: AC 240 V ~, 50 Hz
 Power consumption: 17 W (POWER ON), 3.1 W (STANDBY mode)
 Mass: 4.8 kg
 Dimensions (W x H x D): 435 mm x 127 mm x 329 mm

Video outputs

COMPONENT (pin jacks): Y Output: 1.0 Vp-p (75 Ω)
 Pb/Pr Output: 0.7 Vp-p (75 Ω)
 VIDEO OUT (pin jack): 1.0 Vp-p (75 Ω)
 S-VIDEO OUT (S jack): Y Output: 1.0 Vp-p (75 Ω)
 C Output: 286 mVp-p (75 Ω)
 Horizontal resolution: 500 Lines

Audio outputs

ANALOG OUT (pin jack): 2.0 Vrms (10kΩ)
 DIGITAL OUT: (COAXIAL): 0.5 Vp-p (75 Ω termination)
 (OPTICAL): -21 dBm to -15 dBm (Peak)

Audio characteristics

Frequency response: CD (sampling frequency 44.1 kHz): 2 Hz to 20 kHz
 DVD (sampling frequency 48 kHz): 2 Hz to 22 kHz
 DVD (sampling frequency 96 kHz): 2 Hz to 44 kHz
 Dynamic range: 16 bit: More than 98 dB
 20 bit: More than 106 dB
 24 bit: More than 106 dB
 Wow and flutter: Unmeasurable (less than ± 0.002%)
 Total harmonic distortion: Less than 0.002%

* Specifications and appearance subject to change without prior notice.

Appendix A: Table of languages and their abbreviations

When you select the subtitle language or sound, the languages shown below are displayed as abbreviations. To select the desired language, select the abbreviation corresponding the language you want to.

AA	Afar	FA	Persian	KM	Cambodian	OM	(Afan) Oromo	SU	Sundanese
AB	Abkhazian	FI	Finnish	KN	Kannada	OR	Oriya	SV	Swedish
AF	Afrikaans	FJ	Fiji	KO	Korean (KOR)	PA	Panjabi	SW	Swahili
AM	Ameharic	FO	Faroese	KS	Kashmiri	PL	Polish	TA	Tamil
AR	Arabic	FY	Frisian	KU	Kurdish	PS	Pashto, Pushto	TE	Telugu
AS	Assamese	GA	Irish	KY	Kirghiz	PT	Portuguese	TG	Tajik
AY	Aymara	GD	Scots Gaelic	LA	Latin	QU	Quechua	TH	Thai
AZ	Azerbaijani	GL	Galician	LN	Lingala	RM	Rhaeto-Romance	TI	Tigrinya
BA	Bashkir	GN	Guarani	LO	Laothian	RN	Kirundi	TK	Turkmen
BE	Byelorussian	GU	Gujarati	LT	Lithuanian	RO	Rumanian	TL	Tagalog
BG	Bulgarian	HA	Hausa	LV	Latvian, Lettish	RU	Russian	TN	Setswana
BH	Bihari	HI	Hindi	MG	Malagasy	RW	Kinyarwanda	TO	Tonga
BI	Bislama	HR	Croatian	MI	Maori	SA	Sanskrit	TR	Turkish
BN	Bengali, Bangla	HU	Hungarian	MK	Macedonian	SD	Sindhi	TS	Tsonga
BO	Tibetan	HY	Armenian	ML	Malayalam	SG	Sangho	TT	Tatar
BR	Breton	IA	Interlingua	MN	Mongolian	SH	Serbo-Croatian	TW	Twi
CA	Catalan	IE	Interlingue	MO	Moldavian	SI	Singhalese	UK	Ukrainian
CO	Corsican	IK	Inupiak	MR	Marathi	SK	Slovak	UR	Urdu
CS	Czech	IN	Indonesian	MS	Malay (MAY)	SL	Slovenian	UZ	Uzbek
CY	Welsh	IS	Icelandic	MT	Maltese	SM	Samoan	VI	Vietnamese
DA	Danish	IW	Hebrew	MY	Burmese	SN	Shona	VO	Volapuk
DZ	Bhutani	JL	Yiddish	NA	Nauru	SO	Somali	WO	Wolof
EL	Greek	JW	Javanese	NE	Nepali	SQ	Albanian	XH	Xhosa
EO	Esperanto	KA	Georgian	NL	Dutch	SR	Serbian	YO	Yoruba
ET	Estonian	KK	Kazakh	NO	Norwegian	SS	Siswati	ZU	Zulu
EU	Basque	KL	Greenlandic	OC	Occitan	ST	Sesotho		

Additional information

Appendix B:Country code list for parental lock

This list is used for the parental Lock operation. For details, see page 57.

AD	Andorra
AE	United Arab Emirates
AF	Afghanistan
AG	Antigua and Barbuda
AI	Anguilla
AL	Albania
AM	Armenia
AN	Netherlands Antilles
AO	Angola
AQ	Antarctica
AR	Argentina
AS	American Samoa
AT	Austria
AU	Australia
AW	Aruba
AZ	Azerbaijan
BA	Bosnia and
BB	Barbados
BD	Bangladesh
BE	Belgium
BF	Burkina Faso
BG	Bulgaria
BH	Bahrain
BI	Burundi
BJ	Benin
BM	Bermuda
BN	Brunei Darussalam
BO	Bolivia
BR	Brazil
BS	Bahamas
BT	Bhutan
BV	Bouvet Island
BW	Botswana
BY	Belarus
BZ	Belize
CA	Canada
CC	Cocos (Keeling) Islands
CF	Central African Republic
CG	Congo
CH	Switzerland
CI	Côte d'Ivoire
CK	Cook Islands
CL	Chile
CM	Cameroon
CN	China
CO	Colombia
CR	Costa Rica
CU	Cuba
CV	Cape Verde
CX	Christmas Island
CY	Cyprus
CZ	Czech Republic
DE	Germany
DJ	Djibouti
DK	Denmark
DM	Dominica
DO	Dominican Republic
DZ	Algeria
EC	Ecuador
EE	Estonia
EG	Egypt
EH	Western Sahara
ER	Eritrea
ES	Spain
ET	Ethiopia
FI	Finland
FJ	Fiji
FK	Falkland Islands
FM	Micronesia (Federated States of)
FO	Faroe Islands
FR	France
FX	France, Metropolitan
GA	Gabon
GB	United Kingdom
GD	Grenada
GE	Georgia
GF	French Guiana
GH	Ghana
GI	Gibraltar
GL	Greenland
GM	Gambia
GN	Guinea
GP	Guadeloupe
GQ	Equatorial Guinea
GR	Greece
GS	South Georgia and the South Sandwich
GT	Guatemala
GU	Guam
GW	Guinea-Bissau
GY	Guyana
HK	Hong Kong
HM	Heard Island and McDonald Islands
HN	Honduras
HR	Croatia
HT	Haiti
HU	Hungary
ID	Indonesia
IE	Ireland
IL	Israel
IN	India
IO	British Indian Ocean Territory
IQ	Iraq
IR	Iran (Islamic Republic of)
IS	Iceland
IT	Italy
JM	Jamaica
JO	Jordan
JP	Japan
KE	Kenya
KG	Kyrgyzstan
KH	Cambodia
KI	Kiribati
KM	Comoros
KN	Saint Kitts and Nevis
KP	Korea, Democratic People's Republic of
KR	Korea, Republic of
KW	Kuwait
KY	Cayman Islands
KZ	Kazakhstan
LA	Lao People's Democratic Republic
LB	Lebanon
LC	Saint Lucia
LI	Liechtenstein
LK	Sri Lanka
LR	Liberia
LS	Lesotho
LT	Lithuania
LU	Luxembourg
LV	Latvia
LY	Libyan Arab
MA	Morocco
MC	Monaco
MD	Moldova, Republic of
MG	Madagascar
MH	Marshall Islands
ML	Mali
MM	Myanmar
MN	Mongolia
MO	Macau
MP	Northern Mariana Islands
MQ	Martinique
MR	Mauritania
MS	Montserrat
MT	Malta
MU	Mauritius
MV	Maldives
MW	Malawi
MX	Mexico
MY	Malaysia
MZ	Mozambique
NA	Namibia
NC	New Caledonia
NE	Niger
NF	Norfolk Island
NG	Nigeria
NI	Nicaragua
NL	Netherlands
NO	Norway
NP	Nepal
NR	Nauru
NU	Niue
NZ	New Zealand
OM	Oman
PA	Panama
PE	Peru
PF	French Polynesia
PG	Papua New Guinea
PH	Philippines
PK	Pakistan
PL	Poland
PM	Saint Pierre and Miquelon
PN	Pitcairn
PR	Puerto Rico
PT	Portugal
PW	Palau
PY	Paraguay
QA	Qatar
RE	Réunion
RO	Romania
RU	Russian Federation
RW	Rwanda
SA	Saudi Arabia
SB	Solomon Islands
SC	Seychelles
SD	Sudan
SE	Sweden
SG	Singapore
SH	Saint Helena
SI	Slovenia
SJ	Svalbard and Jan Mayen
SK	Slovakia
SL	Sierra Leone
SM	San Marino
SN	Senegal
SO	Somalia
SR	Suriname
ST	Sao Tome and Principe
SV	El Salvador
SY	Syrian Arab Republic
SZ	Swaziland
TC	Turks and Caicos Islands
TD	Chad
TF	French Southern Territories
TG	Togo
TH	Thailand
TJ	Tajikistan
TK	Tokelau
TM	Turkmenistan
TN	Tunisia
TO	Tonga
TP	East Timor
TR	Turkey
TT	Trinidad and Tobago
TV	Tuvalu
TW	Taiwan, Province of China
TZ	Tanzania, United Republic of
UA	Ukraine
UG	Uganda
UM	United States Minor Outlying Islands
US	United States
UY	Uruguay
UZ	Uzbekistan
VA	Vatican City State (Holy See)
VC	Saint Vincent and the Grenadines
VE	Venezuela
VG	Virgin Islands (British)
VI	Virgin Islands (U.S.)
VN	Vietnam
VU	Vanuatu
WF	Wallis and Futuna Islands
WS	Samoa
YE	Yemen
YT	Mayotte
YU	Yugoslavia
ZA	South Africa
ZM	Zambia
ZR	Zaire
ZW	Zimbabwe

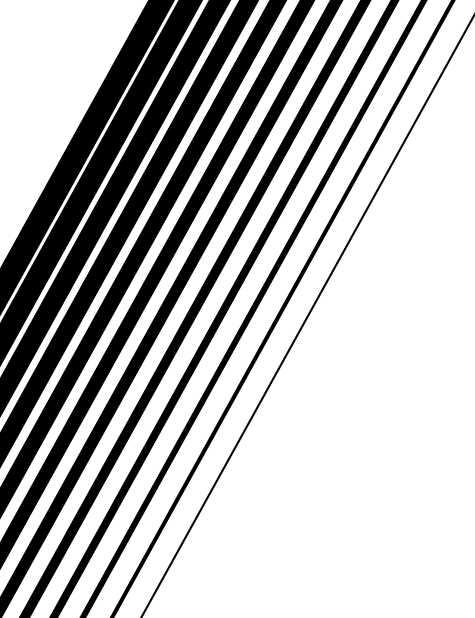

JVC
VICTOR COMPANY OF JAPAN, LIMITED